



Hochschule für Angewandte
Wissenschaften Hamburg
Hamburg University of Applied Sciences



Vortrag für
DGLR / VDI / RAeS / HAW

***Die
Blended Wing Body
(BWB)
Flugzeugkonfiguration***

28.09.2006

Prof. Dr.-Ing. Dieter Scholz, MSME

<https://doi.org/10.5281/zenodo.6515774>



Hochschule für Angewandte
Wissenschaften Hamburg
Hamburg University of Applied Sciences



Lecture for
DGLR / VDI / RAeS / HAW

***The
Blended Wing Body
(BWB)
Aircraft Configuration***

2006-09-26

Prof. Dr.-Ing. Dieter Scholz, MSME



Contents



Introduction

BWB Definition
Strategic Targets
Potential Advantages

Projects

Square-Cube-Law

Aero. Disciplines

BWB Projects
Preliminary Sizing
Aerodynamics
Flight Mechanics
Structures

Air Transport System

Mass Prediction
System Integration
Ground Handling
Emergency
Wake Turbulence
Requirements from Aerodromes

AC20.30

Interior Design
AC20.30:
Test Flights
Wind Tunnel Tests

Summary

Summary



Acknowledgement



Hochschule für Angewandte
Wissenschaften Hamburg
Hamburg University of Applied Sciences



Data for this presentation
was obtained from:

Internet
Literature
Diplomarbeiten / Master Thesis
Team Effort at HAW
Airbus
Personal Communication

Note:

This file contains only a selection of
presented information that was
considered suitable for public release.



Hochschule für Angewandte
Wissenschaften Hamburg
Hamburg University of Applied Sciences



Introduction



BWB Definition

http://en.wikipedia.org/wiki/Blended_Wing_Body



- 1) Conventional Configuration: "Tube and Wing" or "Tail Aft" (Drachenflugzeug)
- 2) Blended Wing Body (BWB)
- 3) Hybrid Flying Wing
- 4) Flying Wing

The **Blended Wing Body** aircraft is a blend of the **tail aft** and the **flying wing** configurations:
A wide **lift producing centre body** housing the payload blends into conventional outer wings.



Strategic Targets

Vision 2020 (January 2001)



ACARE (Advisory Council for Aeronautics Research in Europe)
October 2002 : The Strategic Research Agenda (SRA-1) 5 Challenges

Quality and
Affordability

Environment

Safety

Air Transport
System
Efficiency

Security



October 2004 : The SRA-2 6 High level Target Concepts

Very Low
Cost ATS

Ultra Green
ATS

Highly
Customer
oriented ATS

Highly time-
efficient ATS

Ultra
Secure ATS

22nd
Century

To meet Society's needs

To achieve global leadership for Europe



Strategic Targets

Vision 2020 (January 2001)



Punctuality: 99% of all flights arriving and departing within 15 minutes of the published timetable, in all weather conditions.

Time spent in airports: no more than 15 minutes in the airport before departure and after arrival for short-haul flights, and 30 minutes for long haul.

Aircraft will achieve a **five-fold reduction in the average accident rate** of global operators.

A **reduction in perceived noise to one half** of current average levels.

A **50% cut in CO2 emissions** per pax-km (which means a 50% cut in fuel consumption) and an **80% cut in nitrogen oxide** emissions.

An air traffic management system that can handle **16 million flights ...** in European air space.



Potential Advantages



Hochschule für Angewandte
Wissenschaften Hamburg
Hamburg University of Applied Sciences

BWB target advantages compared to today's advanced aircraft (from different internet sources)

reduction in weight :	10 to 15% less per pax
better L/D :	20 to 25% better
reduction in fuel consumption :	30% less than today
reduction in emissions :	NOX down 17%
reduction in noise :	only with engines on top
increase of airport capacity :	more than 750 pax per A/C
reduction in DOC :	down 12%



DOC: Direct Operating Costs



Square-Cube-Law



Hochschule für Angewandte
Wissenschaften Hamburg
Hamburg University of Applied Sciences

The BWB configuration is favoured for ultra large aircraft.
Why does physics demand a BWB?

Geometric Scaling: $V \propto l^3$ $m \propto l^3$ $m_{MTO} \propto l^3$

$$S_W \propto l^2$$

Landing Field Length and Approach Speed is limited:

$$\Rightarrow \frac{m_{MTO}}{S_W} = const \wedge m_{MTO} \propto l^3 \Rightarrow S_W \propto l^3$$

Square-Cube-Law



Square-Cube-Law



Hochschule für Angewandte
Wissenschaften Hamburg
Hamburg University of Applied Sciences

The BWB configuration is favoured for ultra large aircraft.
Why does physics demand a BWB?

$$S_W \propto l^3$$

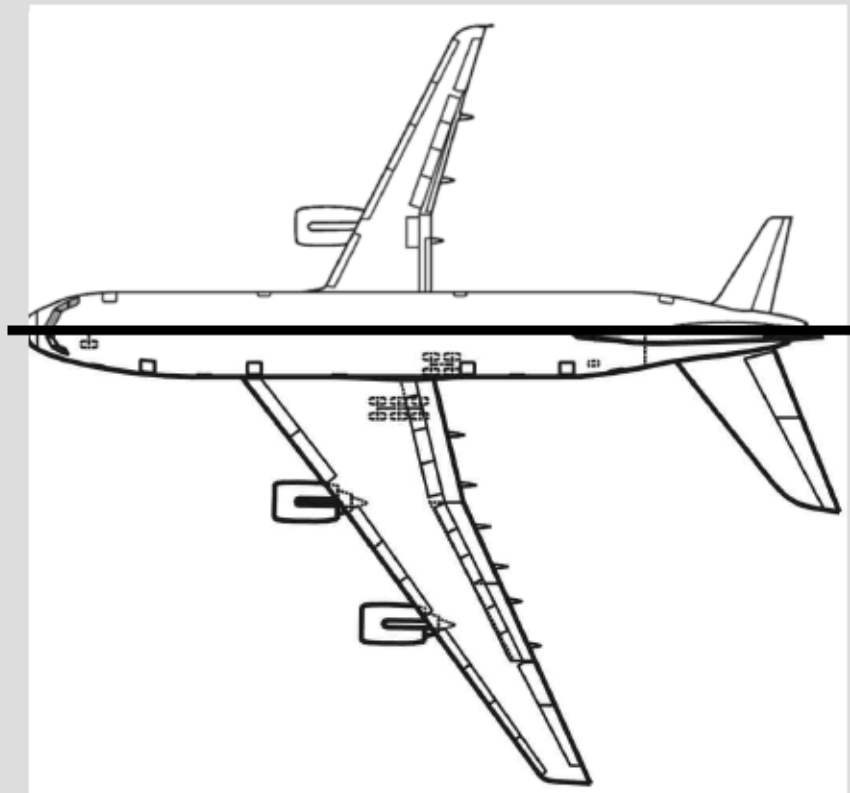

A321 scaled to the same size
as the A380.

A321: $\frac{m_{MTO}}{S_W} = 727 \text{ kg/m}^2$

A380-800F: $\frac{m_{MTO}}{S_W} = 698 \text{ kg/m}^2$

Aircraft even bigger => BWB



Hochschule für Angewandte
Wissenschaften Hamburg
Hamburg University of Applied Sciences



BWB Projects



BWB Projects



Hochschule für Angewandte
Wissenschaften Hamburg
Hamburg University of Applied Sciences

http://www.aircrash.org/burnelli/ch_rb1.htm

Burnelli RB-1: Lifting Body and Wings



1921 - Long Island, NY
Burnelli RB-1 -- the first lifting-body
reduced to practice.

In 1921 pioneering aviator
and aircraft designer
Vincent Justus Burnelli
patented the concept of an
airfoil shaped airframe to
increase the lift and load
capacity of aircraft.



Burnelli RB-1 interior (half)



BWB Projects



Hochschule für Angewandte
Wissenschaften Hamburg
Hamburg University of Applied Sciences

Aerospatiale "Megajet"

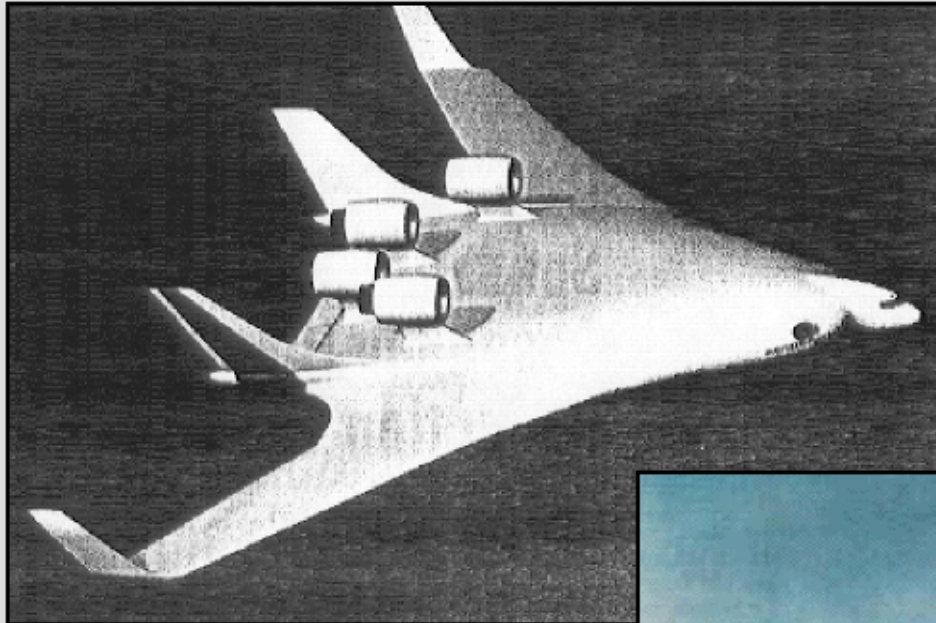

Design study, 1995:
1000 seats,
range 6450 NM,
span 96 m,
cruise at Mach 0.85.

Aviation Week, Aug. 7, 1995 pp.33

<http://aero.stanford.edu/bwbfiles/AerospatialeBWB.html>



S. Lee, Diplomarbeit,
Hamburg University of Applied Sciences



BWB Projects



Hochschule für Angewandte
Wissenschaften Hamburg
Hamburg University of Applied Sciences

MDC, NASA, Stanford: BWB-17



17 ft span
radio controlled model aircraft

<http://aero.stanford.edu/~frl/bwb/BWBProject.html>
<http://www.boeing.com/news/releases/mdc/97-158.html>

1997:
McDonnell Douglas (R. Liebeck),
NASA,
Stanford (Ilan Kroo), et. al.





BWB Projects



Hochschule für Angewandte
Wissenschaften Hamburg
Hamburg University of Applied Sciences

NASA CR-2003-212670

Boeing BWB-450

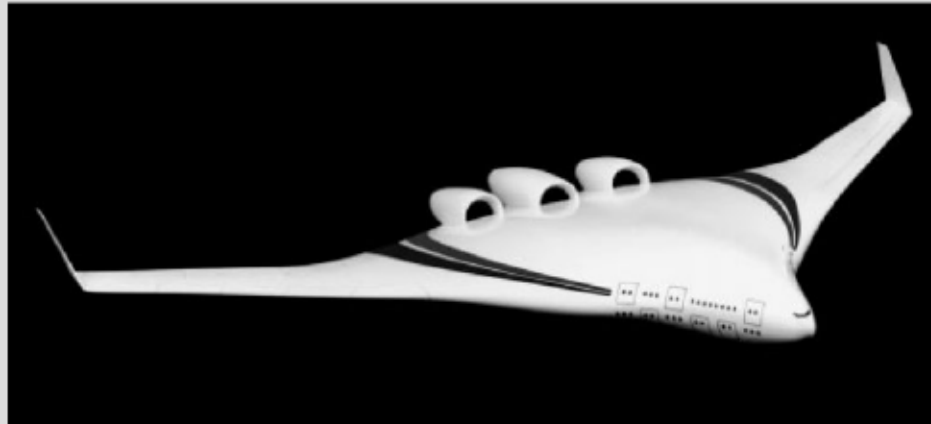

Blended Wing Body systems studies based on BWB-450 as part of the programme Ultra Efficient Engine Technology (UEET): Boundary Layer Ingestion (BLI) inlets with Active Flow Control (AFC).





BWB Projects

Boeing X-48

http://en.wikipedia.org/wiki/Boeing_X-48

Boeing; NASA; Old Dominion University, Norfolk, Va:

- 2001 construction started
- 2002 completion
- 2003 integration and ground tests
- 2004 wind tunnel tests
- 2004 flight test was planned with max. 165 mph at 10000 ft.
no flight test results reported!

35 ft span wind tunnel and flight test model
(called BWB-LSV; low speed vehicle).

Original:
450 seats
span 250 ft = 76.2 m



BWB Projects



Hochschule für Angewandte
Wissenschaften Hamburg
Hamburg University of Applied Sciences

Boeing X-48B

http://en.wikipedia.org/wiki/Boeing_X-48
Flight International, 30/05/06

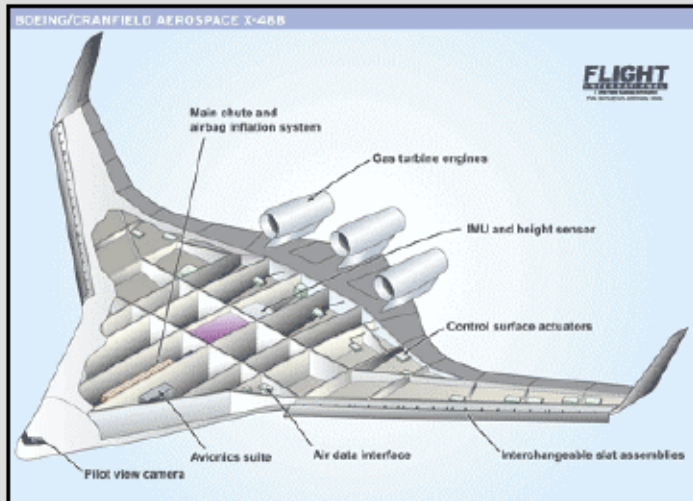

2006: Boeing, NASA, U.S. Air Force.
21 ft span wind tunnel and flight test
model. Two X-48B are built. Original:
450 seats,
range 7000 NM,
span 75.3 m,
cruise:
high subsonic.





BWB Projects



Hochschule für Angewandte
Wissenschaften Hamburg
Hamburg University of Applied Sciences

Boeing X-48B - tanker



Air Force
Research Laboratory
(AFRL)



BWB Projects



Hochschule für Angewandte
Wissenschaften Hamburg
Hamburg University of Applied Sciences

Boeing X-48B - tanker



X-48B prototypes were built for Boeing Phantom Works by Cranfield Aerospace Ltd.



The X-48B prototypes have been dynamically scaled to represent a much larger aircraft.



BWB Projects



Hochschule für Angewandte
Wissenschaften Hamburg
Hamburg University of Applied Sciences

Boeing BWB-250 ... BWB-550

F. Bansa, Diplomarbeit,
Hamburg University of
Applied Sciences

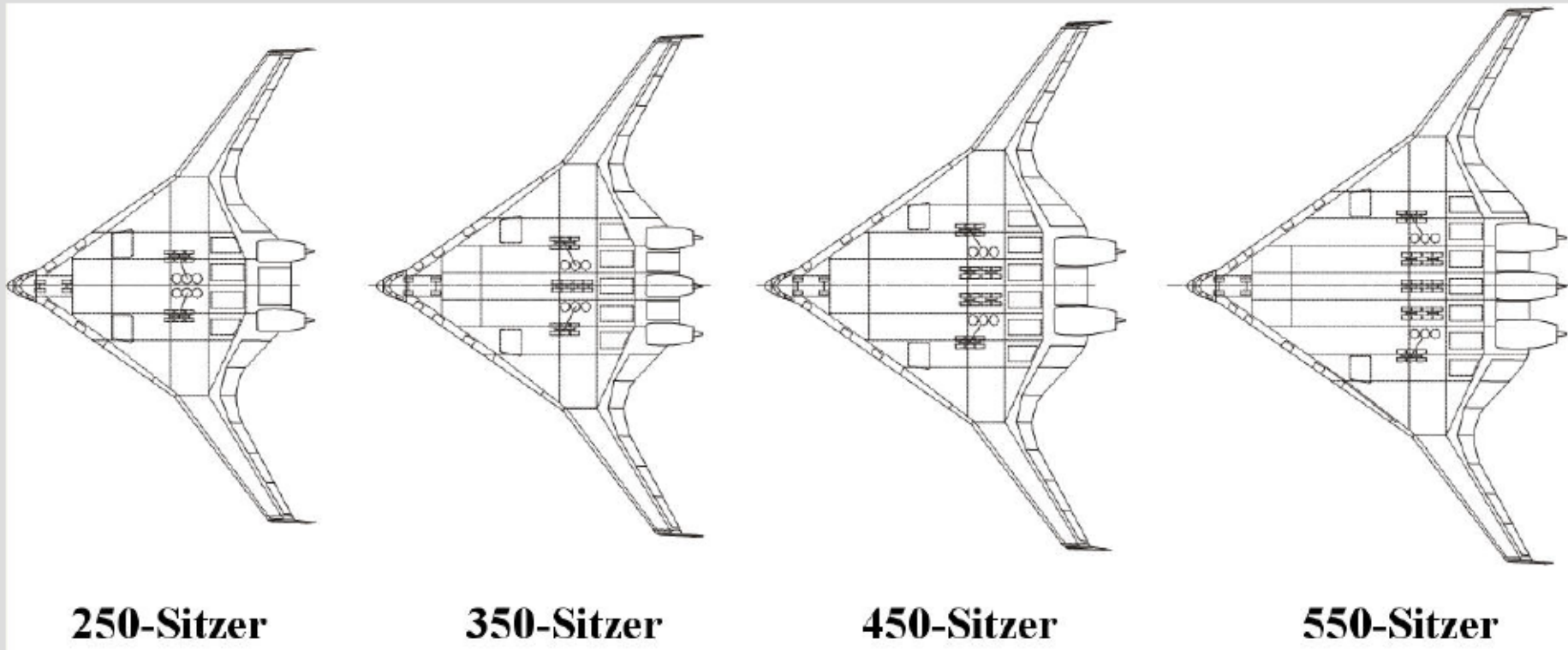

Boeing: study of BWB aircraft family

Today BWBs are not a topic anymore at Boeing for civil transport!



BWB Projects



Hochschule für Angewandte
Wissenschaften Hamburg
Hamburg University of Applied Sciences

TsAGI (Russia) Integrated Wing Body (IWB)

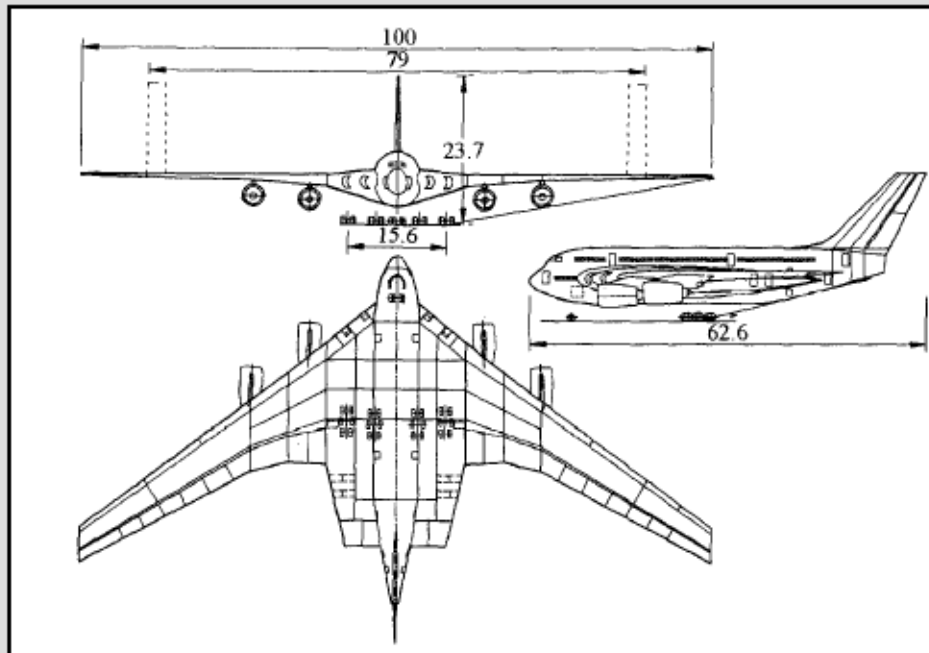

Best configuration from comparison of four New Large Aircraft configurations based on VELA specification.

Research sponsored by
AIRBUS INDUSTRIE

AIRCRAFT DESIGN, Vol 4 (2001)

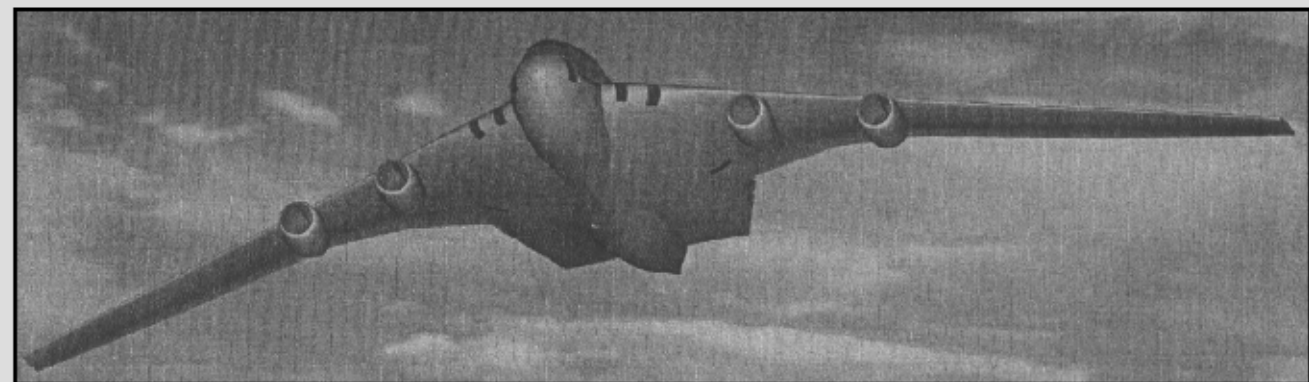



BWB Projects

5th Framework Programme of the European Commission: VELA and MOB



1999 - 2002



17 partners: D, F, UK, E,
I, NL, CZ, P

Very Efficient Large Aircraft (**VELA**)

Three datum configurations for a flying wing (VELA 1, VELA 2 and VELA 3).
A first step in a long-term work plan was followed by further research work.
Passenger-carrying aircraft.

Multidisciplinary Optimisation of a BWB (**MOB**)
Freighter version.



BWB Projects



Hochschule für Angewandte
Wissenschaften Hamburg
Hamburg University of Applied Sciences

VELA 1

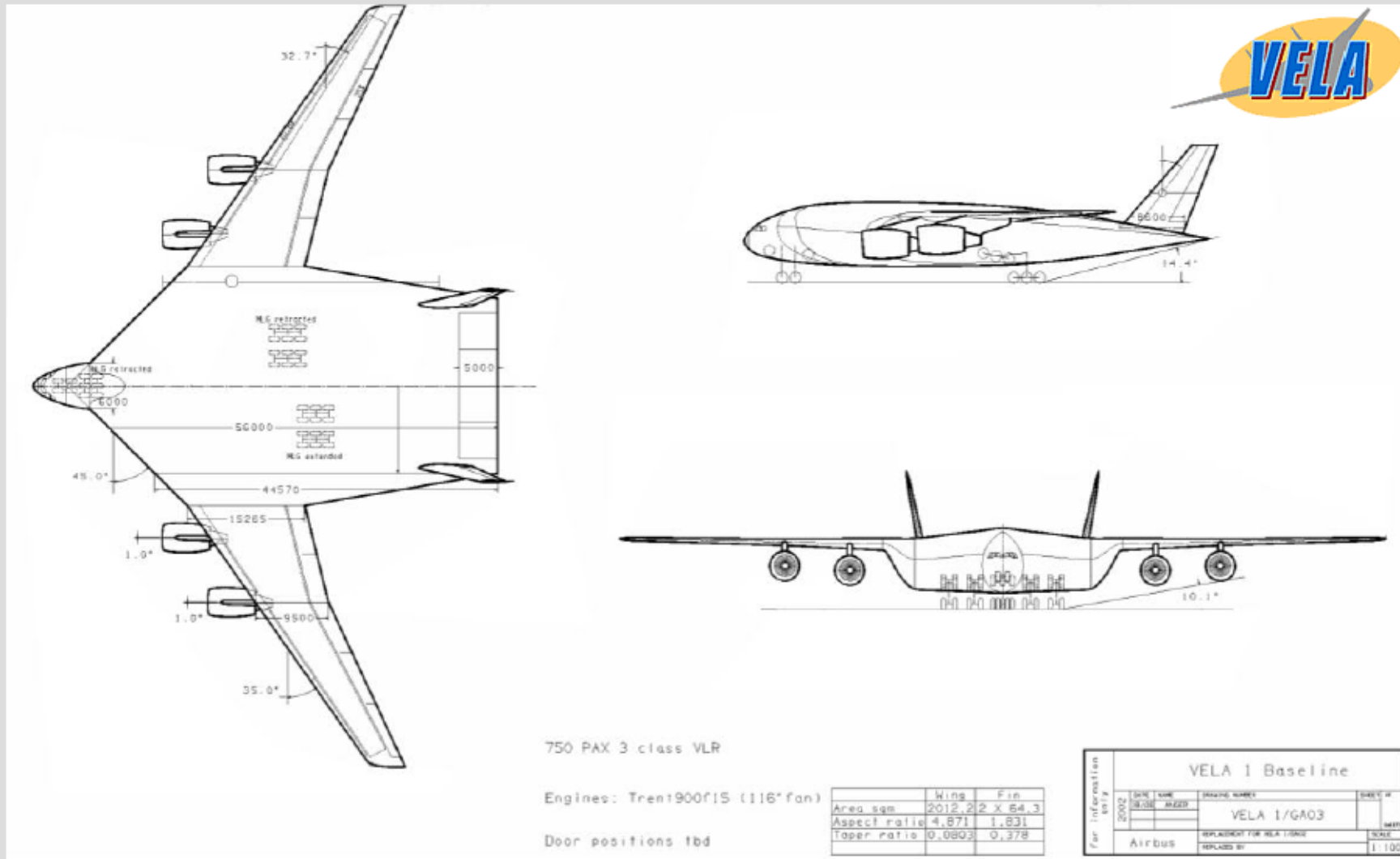



BWB Projects



Hochschule für Angewandte
Wissenschaften Hamburg
Hamburg University of Applied Sciences

VELA 2

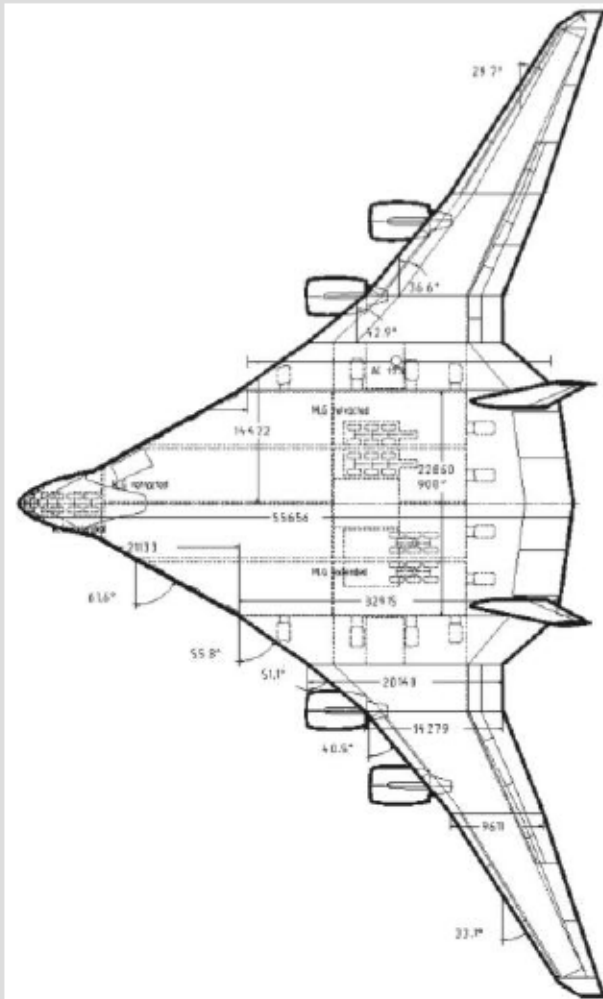

750 PAX 3 class VLR

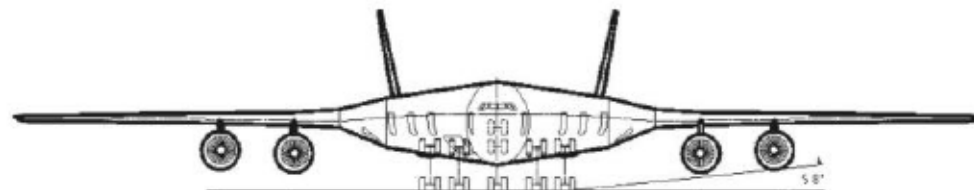
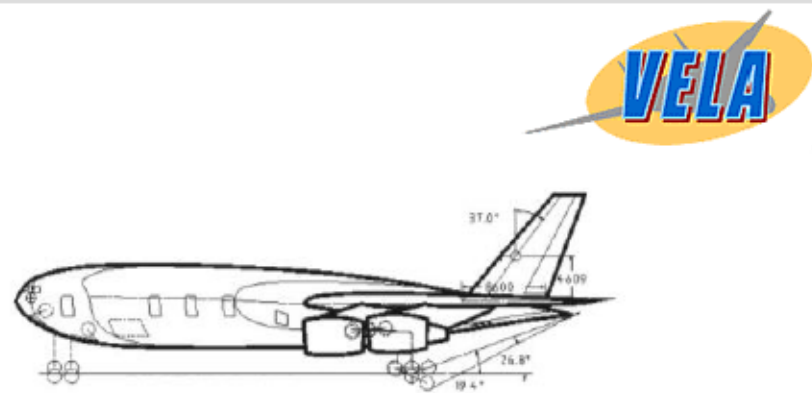

	Wing	Fin
Area sqm	1927,7	2 X 64,29
Aspect ratio	5,59	1,83
Taper ratio	0,04	0,378

VELA 2 Baseline				
DATE	REV	AREA	ISSUE NUMBER	SHEET #
2003	25/07		VELA 2/GA05	28/31
APPROVED FOR VELA DRAW				SCALE
Airbus				1:100
DRAWN BY				



BWB Projects

6th Framework Programme of the European Commission: NACRE with PDA



2003 - 2006

- WP3: Payload Driven Aircraft
(also: VELA 3 continued)
- WP4: Flying scale model for
novel aircraft configuration



National: LuFo III, K2020

BWB (VELA 2) der Uni Stuttgart





BWB Projects

http://www.wingco.com/atlantica_design.htm

Atlantica Blended Wing & Body - Five Place Simplebuild™

Seats:	5
Span:	8.53 m
Range:	1800 NM
Max. Cruise Speed:	240 kt (TAS)
MTOW:	1134 kg
Power:	175 kW

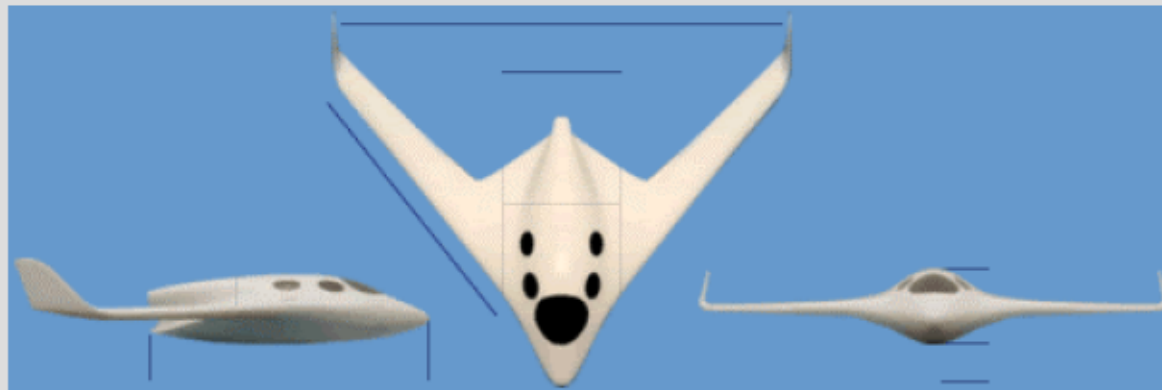
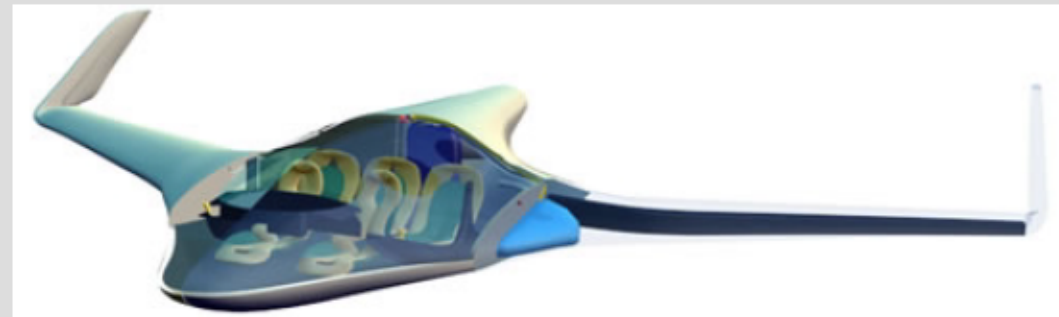



BWB Projects

HAW Student Project: AC 20.30

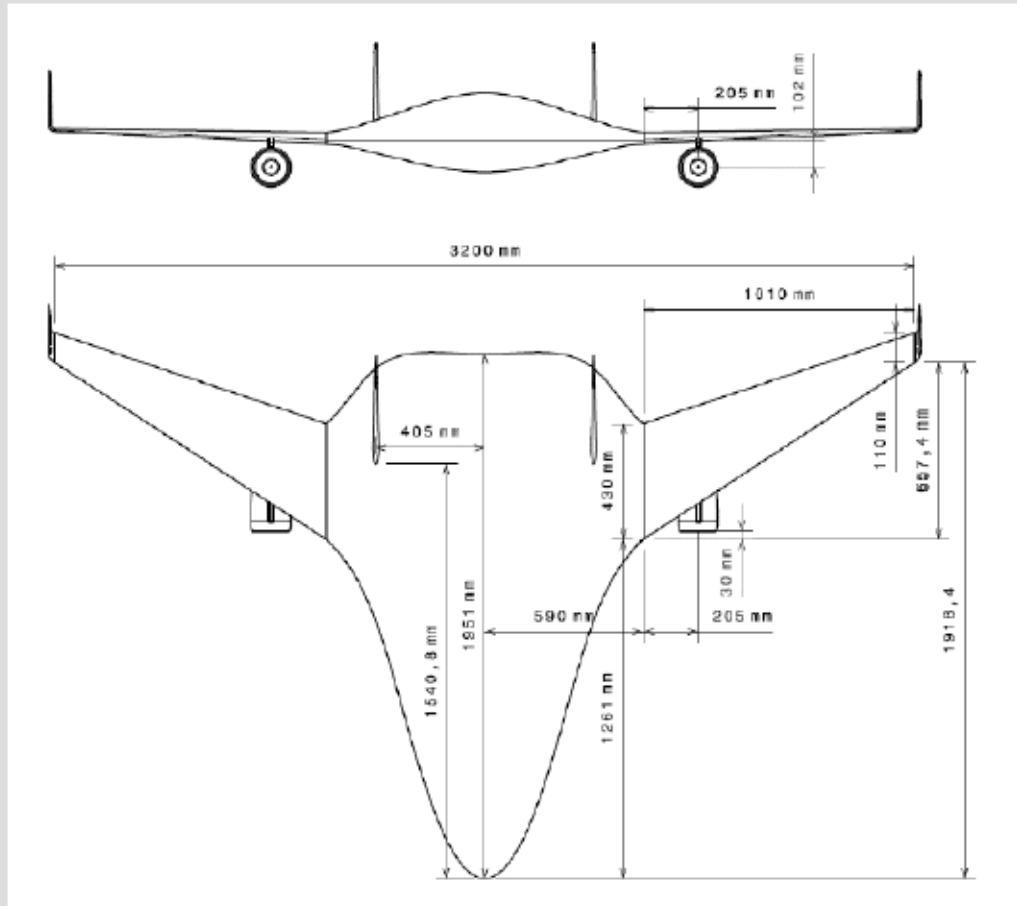

Wing profile: MH-45
(Martin Hepperle)
 $t/c = 9.85\%$,
low drag, improved max. lift,
low $c_{m, c/4}$,
proven even at Reynolds
numbers below 200000.
Body profile: MH-91.

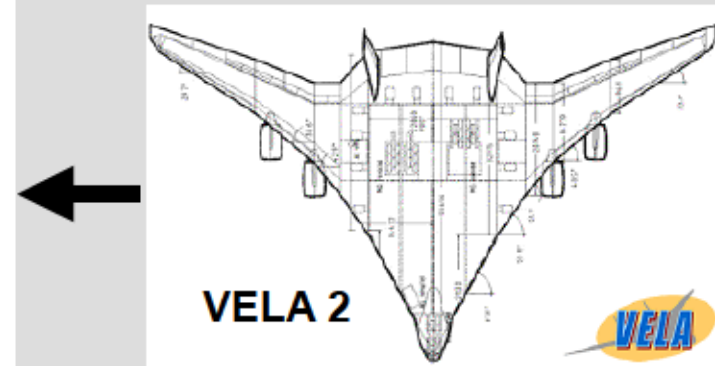

AC 20.30: geometry is based on VELA 2; student project; sponsor: "Förderkreis"





Hochschule für Angewandte
Wissenschaften Hamburg
Hamburg University of Applied Sciences



Aeronautical Disciplines



Preliminary Sizing

Input Parameters for Preliminary Sizing

Estimation of **maximum glide ratio** $E = L/D$ in normal cruise

- A** : aspect ratio
- S_{wet}** : wetted area
- S_W** : reference area of the wing
- e** : Oswald factor; passenger transports: $e \approx 0.85$

$$E_{max} = k_E \sqrt{\frac{A}{S_{wet} / S_W}}$$

from statistics: $k_E = 15,8$

$$k_E = \frac{1}{2} \sqrt{\frac{\pi e}{c_f}} = 14.9$$

S_{wet} / S_W :	conv. aircraft	6.0 ... 6.2
	BWB	≈ 2.4
A :	conv. aircraft	7.0 ... 10.0
	VELA 2	5.2

$$\overline{c_f} = 0.003$$

$E_{max} = 23,2$



Preliminary Sizing

Input Parameters for Preliminary Sizing

Estimation of maximum glide ratio $E = L/D$ in normal cruise

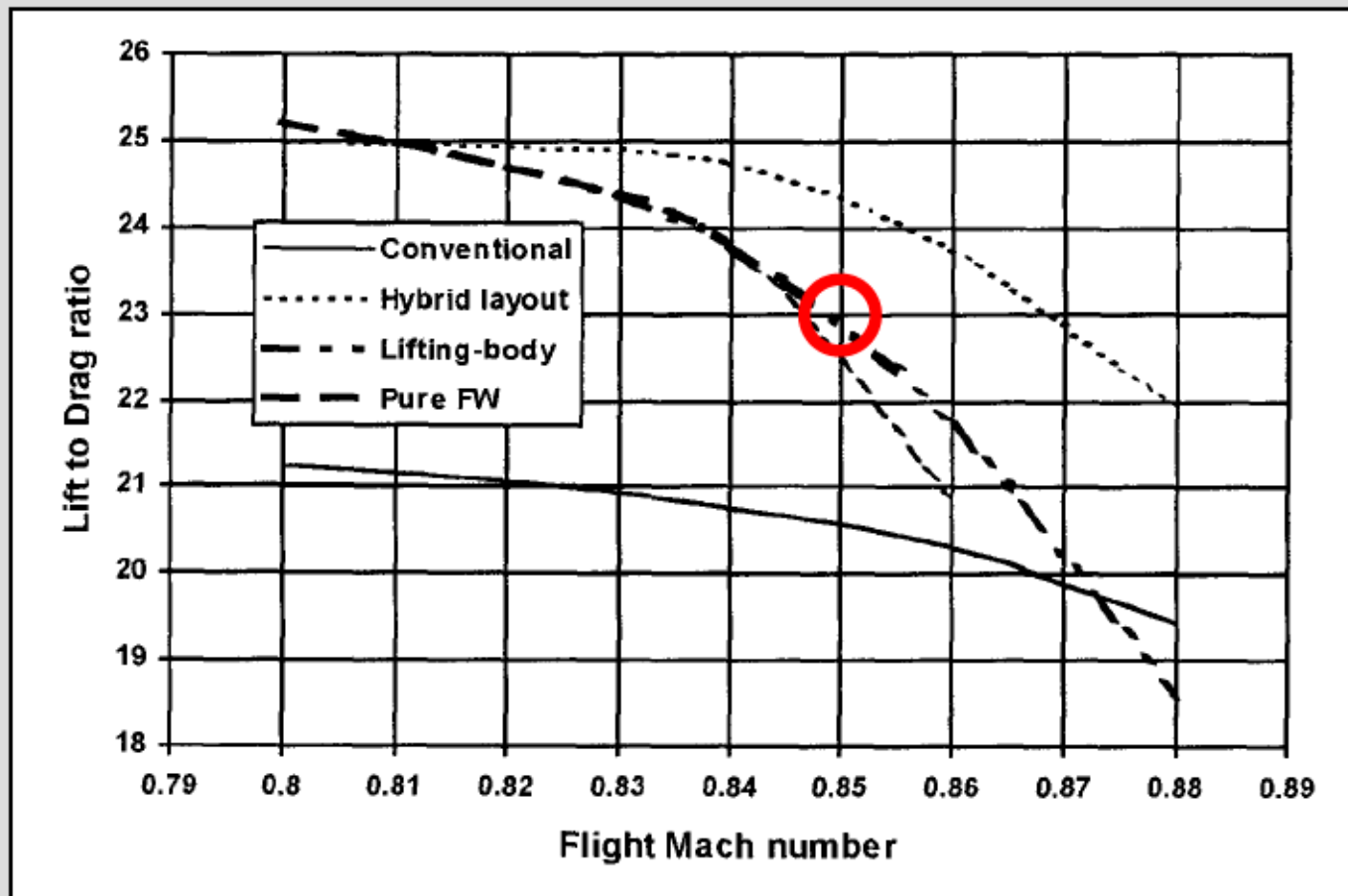



Preliminary Sizing

Input Parameters for Preliminary Sizing

H. Zingel

Estimation of **maximum lift coefficient** take-off and landing

$$C_{L,max} = C_{L,0} + \frac{\partial C_L}{\partial \alpha} \alpha + \frac{\partial C_L}{\partial \eta_W} \eta_W + \frac{\partial C_L}{\partial \eta_B} \eta_B = 0.73$$

Wind tunnel measurements of AC 20.30:

$$C_{L,0} = 0$$

$$\frac{\partial C_L}{\partial \eta_W} = 0.22$$

$$\frac{\partial C_L}{\partial \eta_B} = 0.43$$

$$\frac{\partial C_L}{\partial \alpha} = 2,5$$

$$\alpha = 12^\circ$$

$$\eta_W = 18^\circ$$

$$\eta_B = 18^\circ$$



Preliminary Sizing



Hochschule für Angewandte
Wissenschaften Hamburg
Hamburg University of Applied Sciences

VELA Technical Data



Requirements:

3-class seating: 750 pax (22 / 136 / 592)

cargo capacity > 10 t

range: 7500 NM (200 NM to alternate, 30 min. holding, 5% trip fuel allowance)

high density seating: 1040 pax

cruise Mach number: 0.85

M_{MO} : 0.89

take-off field length < 3350 m (MTOW, SL, ISA +15°C)

approach speed < 145 kt (here: approach speed = 165 kt)

ICA (300 ft/min, max. climb) > 35000 ft

time to ICA (ISA) < 30 min.

max. operating altitude > 45000 ft (=> cabin Δp)

runway loading (ACN, Flex. B) < 70

span < 100 m

wheel spacing < 16 m

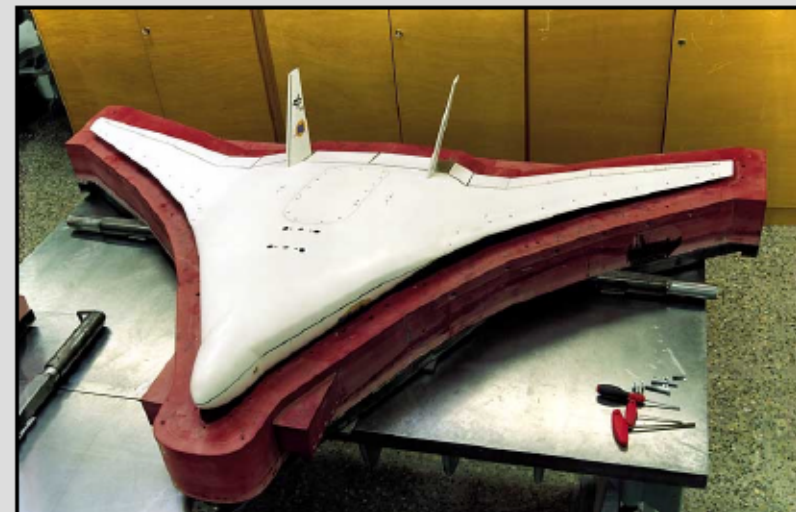



Preliminary Sizing



Hochschule für Angewandte
Wissenschaften Hamburg
Hamburg University of Applied Sciences

VELA 2 Sizing Study at HAW

Assumptions:

OEW / MTOW = 0,5

SFC = 1.4 mg/(Ns)

approach speed = 165 kt

mass of pax and luggage

LOFTIN: 0,52 A380: 0,49 VELA 2: 0.55 → 0.48

latest technology assumed (GENx)

for long distance flying: 97.5 kg per pax

Given:

Wing Area:

1923 m²



Preliminary Sizing

VELA 2 Sizing Study at HAW

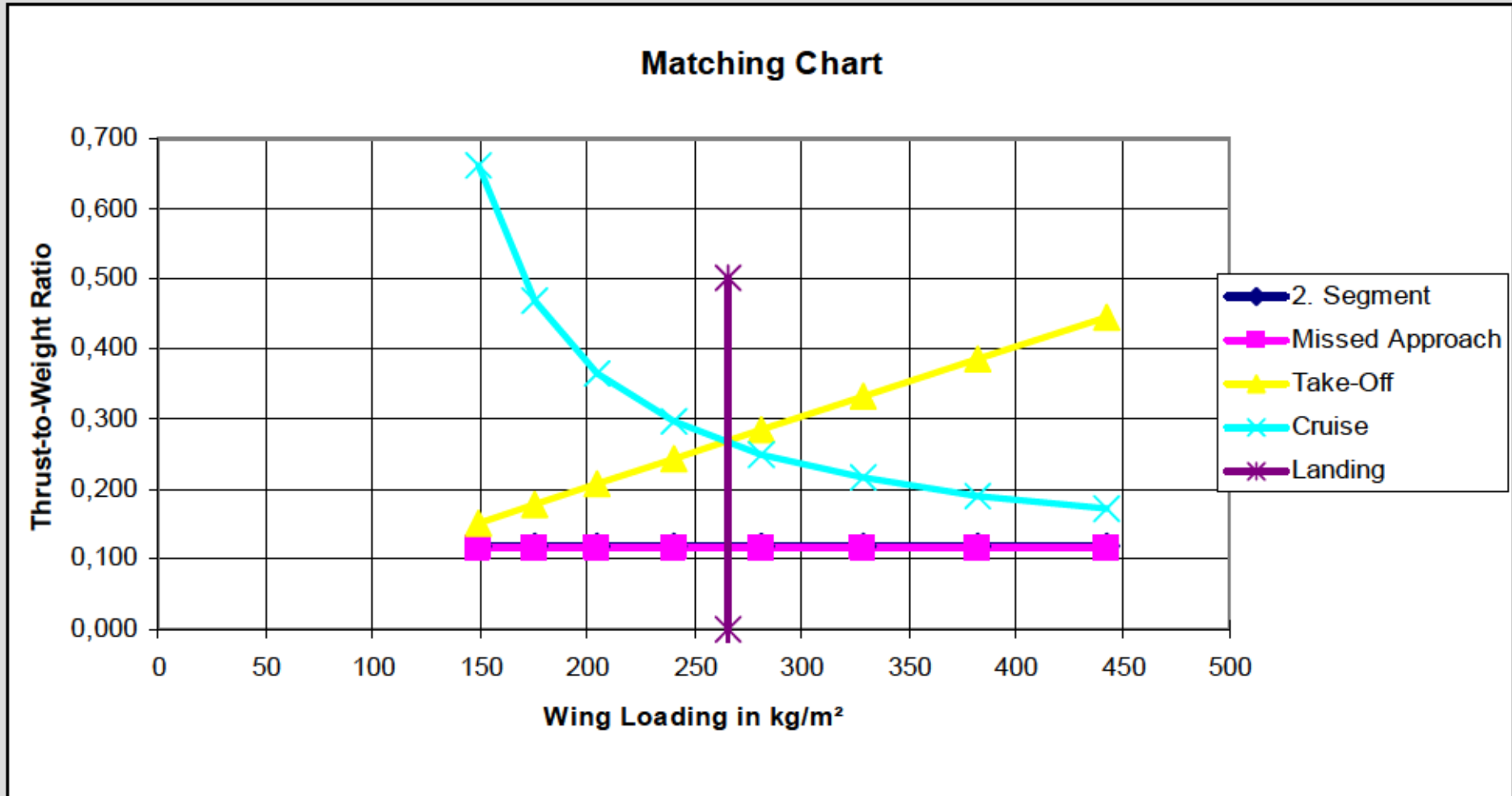



Preliminary Sizing

VELA 2 Sizing Study at HAW

Sizing Results:

<i>L/D</i> during 2. segment:	17.0	(higher than conv. due to small lift coefficient and small drag).
<i>L/D</i> during missed approach:	11.0	(normal, because landing gear drag dominates, FAR!)
$V / V_{md} = 1.09$		(normal: $V / V_{md} = 1.0 \dots 1.316$) $\Rightarrow E = 22.8$
lift coefficient cruise:	0.25	
trust to weight ratio:	0.28	(value is slightly high for 4-engined A/C, reason: TOFL and C_L)
wing loading:	260 kg/m ²	(very low for passenger transport, due to low lift coefficient)
Initial Cruise Altitude (ICA):	38400 ft	(= 11.7 km)
payload:	83000 kg	
MTOW:	501000 kg	(VELA 2: 691200 kg)
Wing Area:	1923 m ²	(VELA 2: 1923 m ² - forced to fit)
MLW:	366000 kg	
OEW:	251000 kg	(VELA 2: 380600 kg)
Fuel:	167000 kg	(VELA 2: 278200 kg ?)
Thrust:	344 kN	(for each of the four engines)



Preliminary Sizing

VELA 3 Sizing Study at HAW

Assumptions:

OEW / MTOW = 0,5

SFC = 1.6 mg/(Ns)

approach speed = 165 kt

Reserves:

LOFTIN: 0,52 (T/W) A380: 0,49 BWB structural benefits?
normal technology level assumed

200 NM to alternate, 30 min. holding, 5% trip fuel allowance

Given:

range: 7650 NM

MTOW: 700000 kg

Wing Area: 2052 m²

Wing Loading: 341 kg/m² (very low for pass. transp. due to low lift coeff.)

mass of pax and luggage: 95.0 kg per pax

payload: 71250 kg



Preliminary Sizing

VELA 3 Sizing Study at HAW

Matching Chart

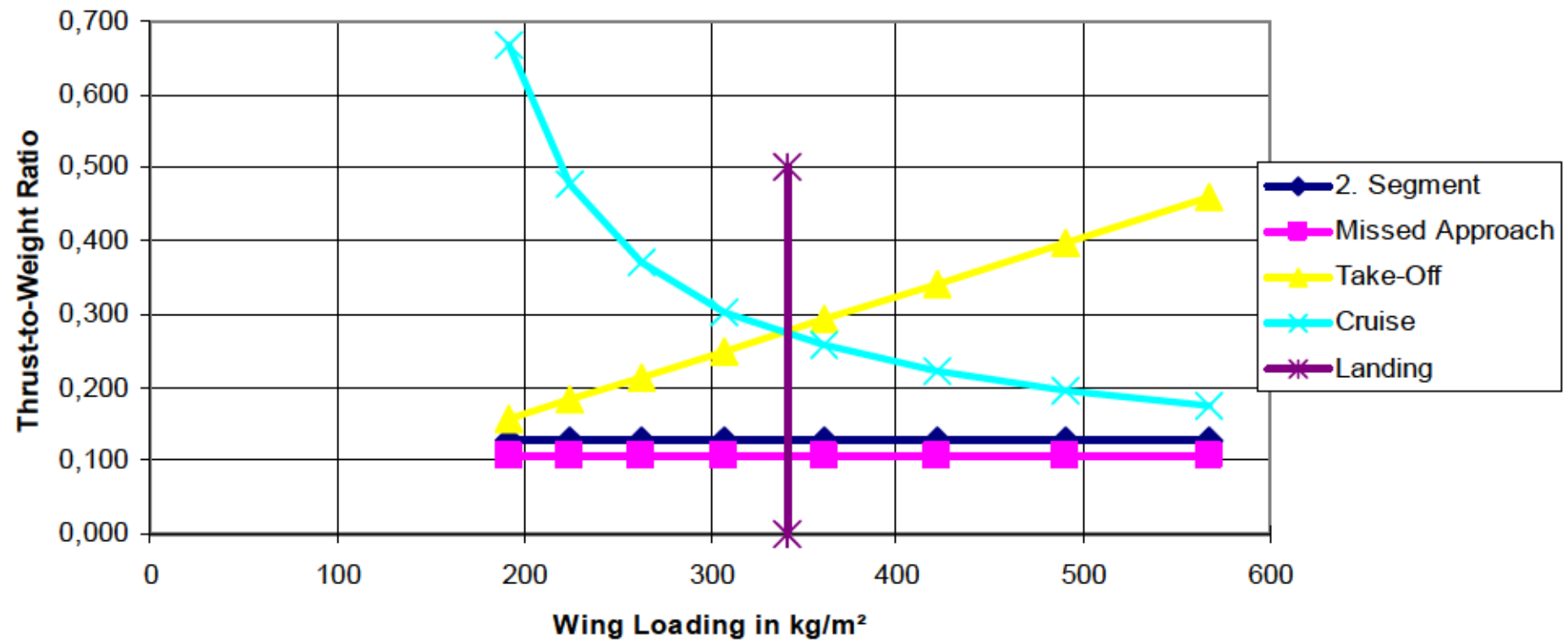



Preliminary Sizing

VELA 3 Sizing Study at HAW

Sizing Results:

lift coefficient landing: 0.86 (higher than HAW wind tunnel results)
 L/D during 2. segment: 15.2 (higher than conv. due to small lift coefficient and small drag)
 L/D during missed approach: 11.0 (normal, because landing gear drag dominates, FAR!)
 L/D_{max} : 20.9 (lower than BWB estimate)
 $V / V_{md} = 1.0$ $\Rightarrow L/D = L/D_{max}$ (normal: $V / V_{md} = 1.0 \dots 1.316$)
lift coefficient cruise: 0.31
trust to weight ratio: 0.28 (value is slightly high for 4-engined A/C, reason: TOFL and C_L)
Initial Cruise Altitude (ICA): 37800 ft (= 11.7 km)
MLW: 469000 kg
OEW: 350000 kg
Fuel: 279000 kg (VELA 3: 282800 kg)
Thrust: 481 kN (for each of the four engines)



Aerodynamics

AC20.30: CFD with FLUENT

H. Brunswig, Diplomarbeit,
Hamburg University of Applied Sciences

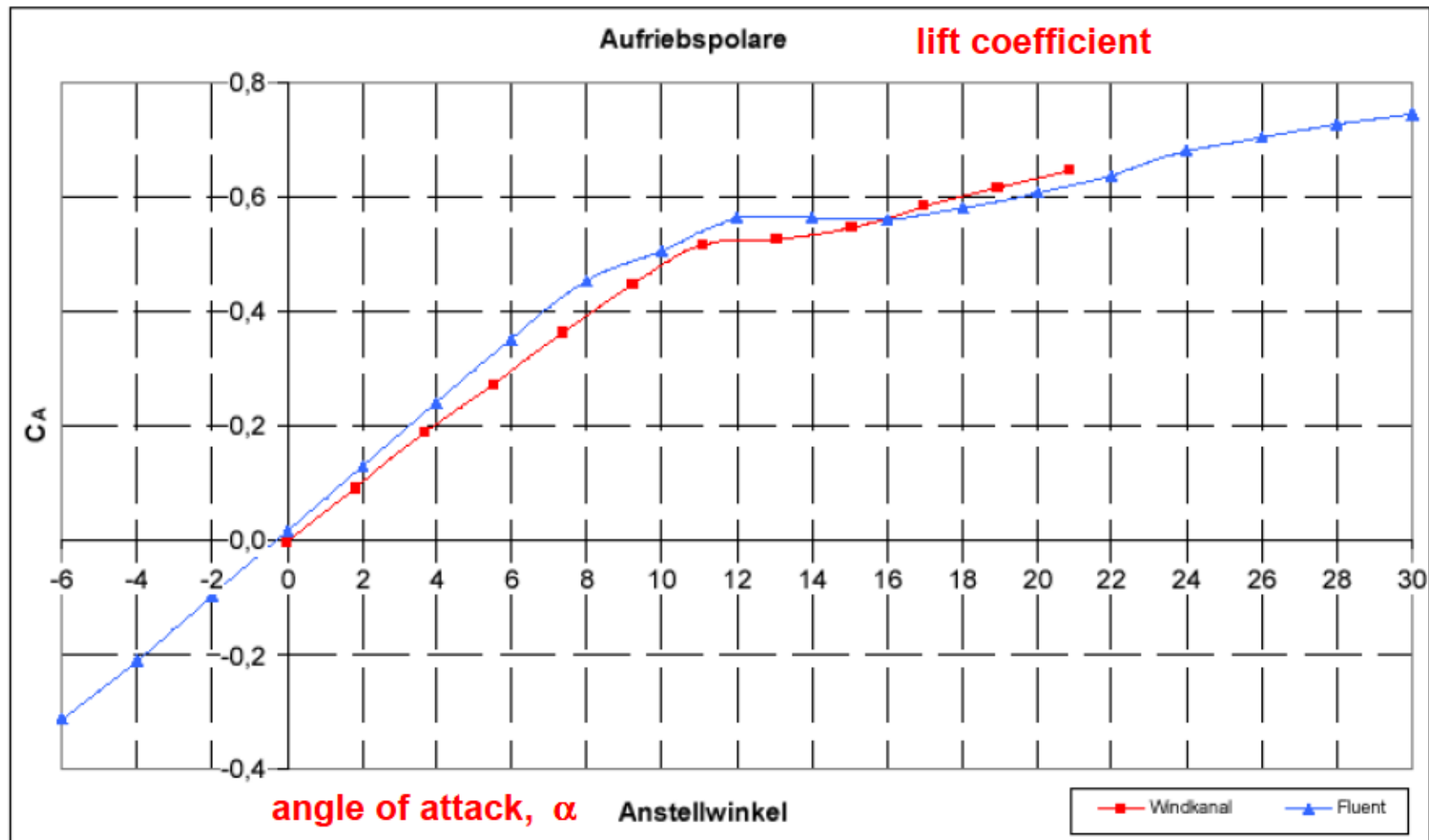



Aerodynamics

AC20.30: CFD with FLUENT

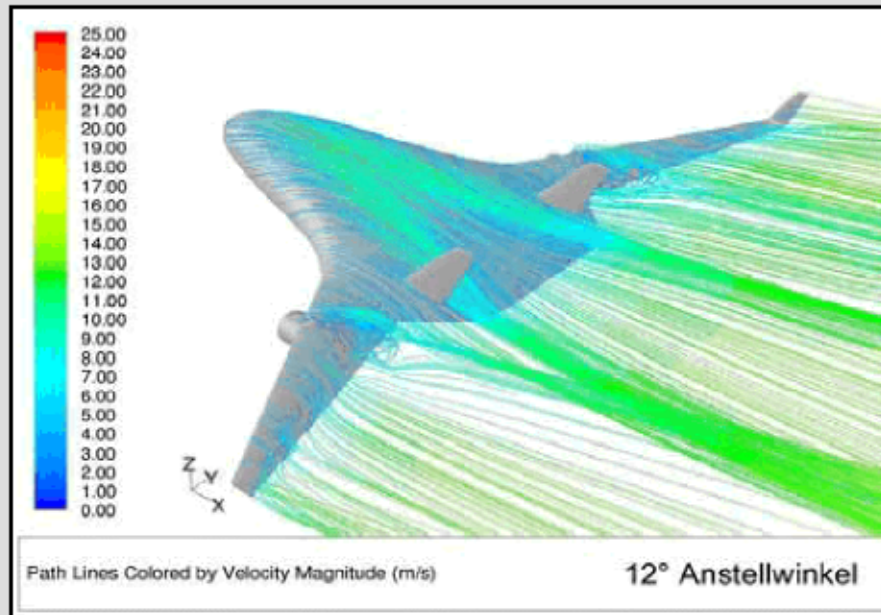

path lines

Stalls can easily be handled
Usable lift up to AOA of 12°
At 22° AOA:

wings are stalled
body continues to produce lift
but control surfaces do not
deliver control power

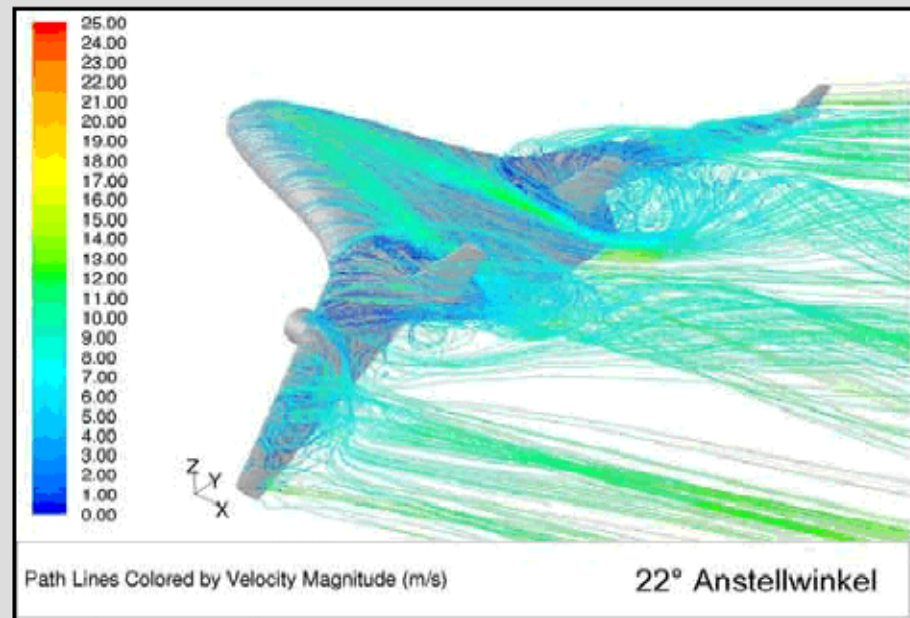



Aerodynamics



Hochschule für Angewandte
Wissenschaften Hamburg
Hamburg University of Applied Sciences

AC20.30: CFD with FLUENT

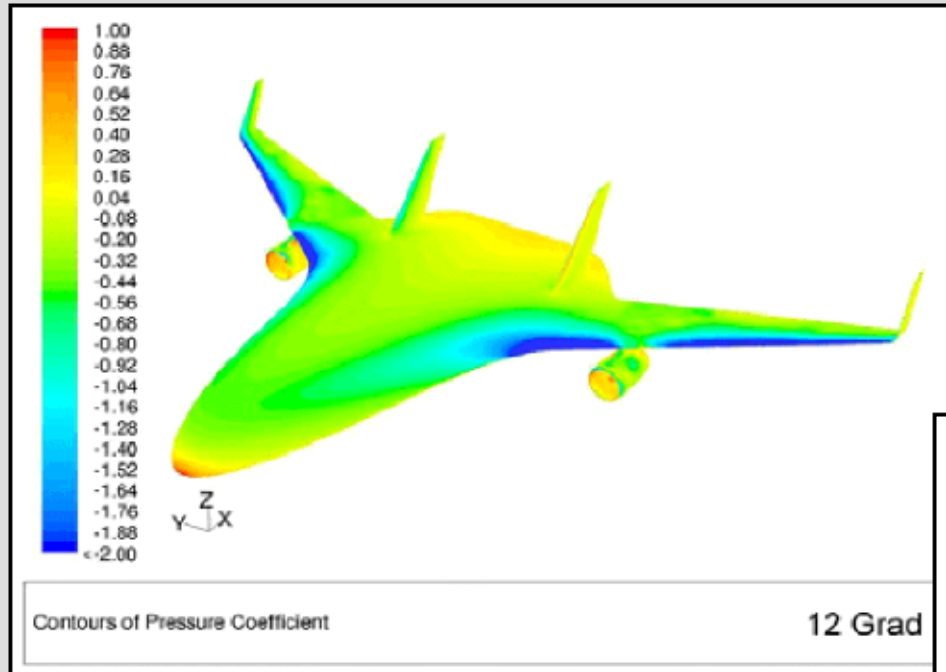

pressure coefficient

$$c_p = \frac{p - p_\infty}{q} = 1 - \left(\frac{V}{V_\infty} \right)^2$$

$$q = \frac{1}{2} \rho V^2$$

dynamic pressure

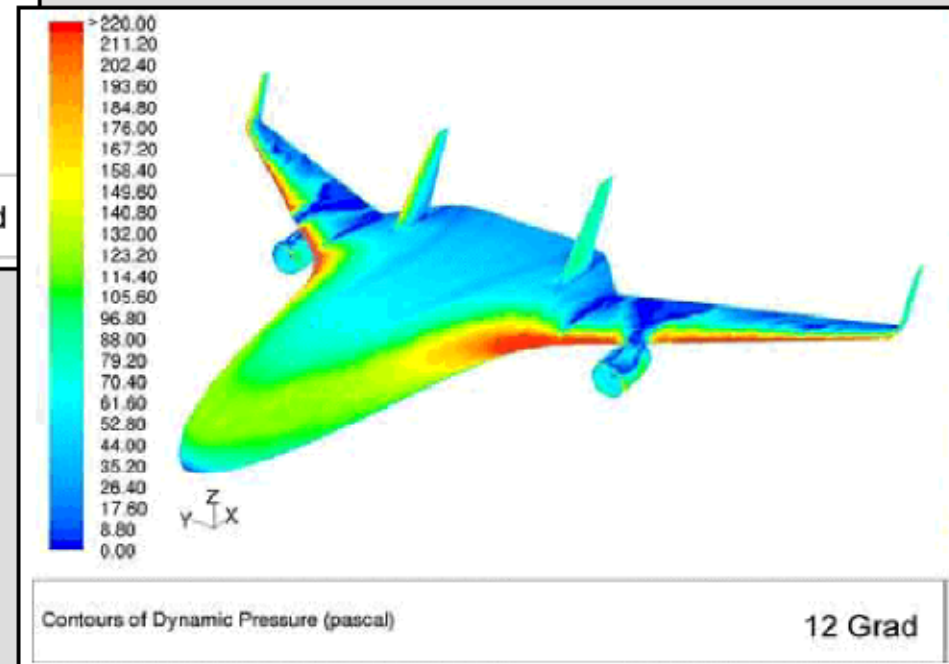



Aerodynamics

AC20.30: CFD with FLUENT

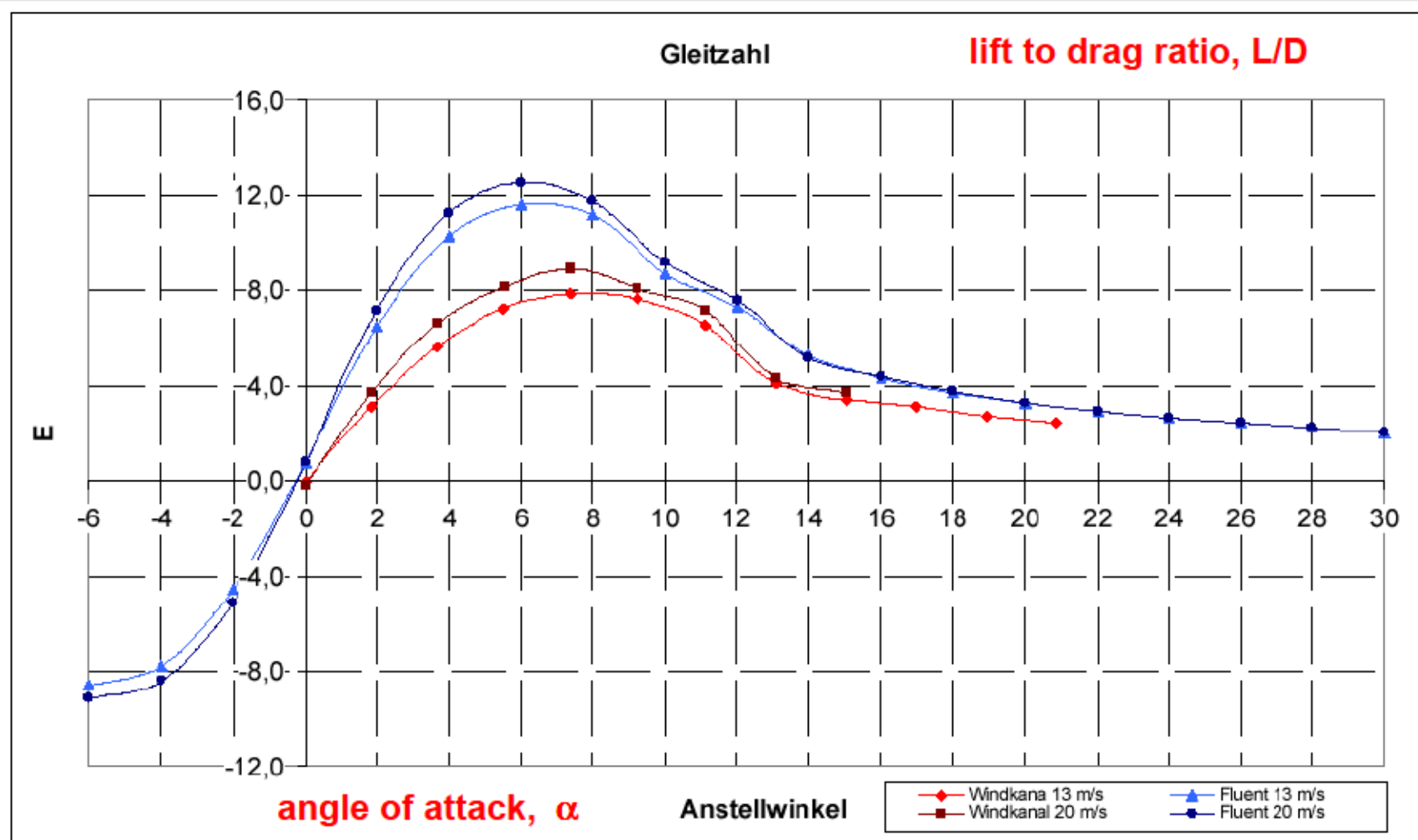



Aerodynamics



Hochschule für Angewandte
Wissenschaften Hamburg
Hamburg University of Applied Sciences

AC20.30: CFD with FLUENT

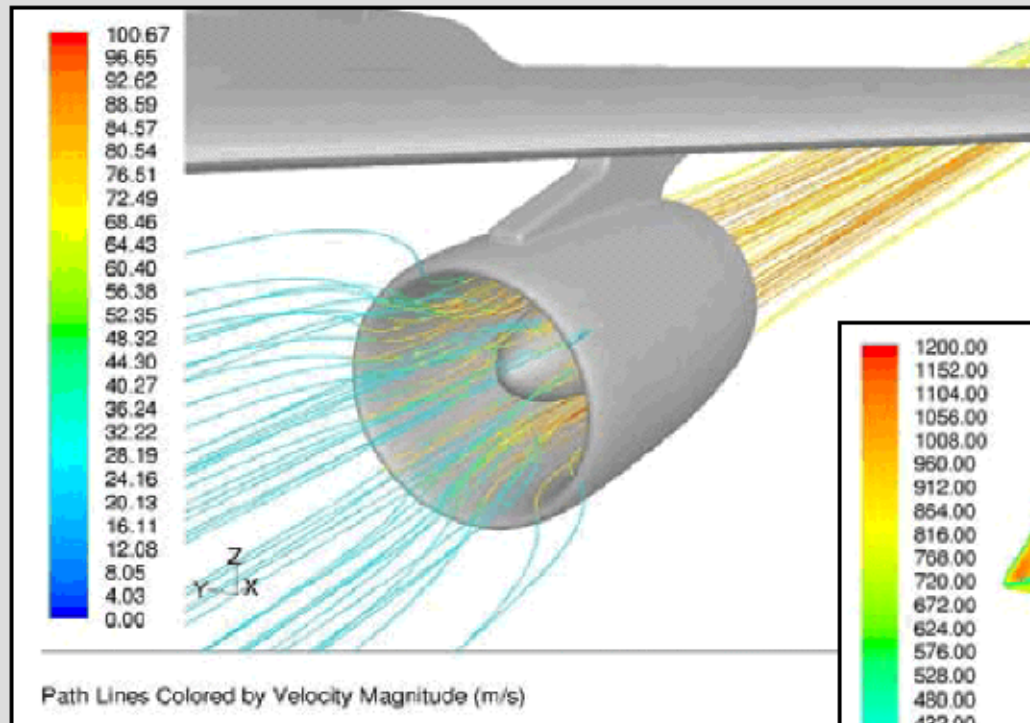

Engine Integration

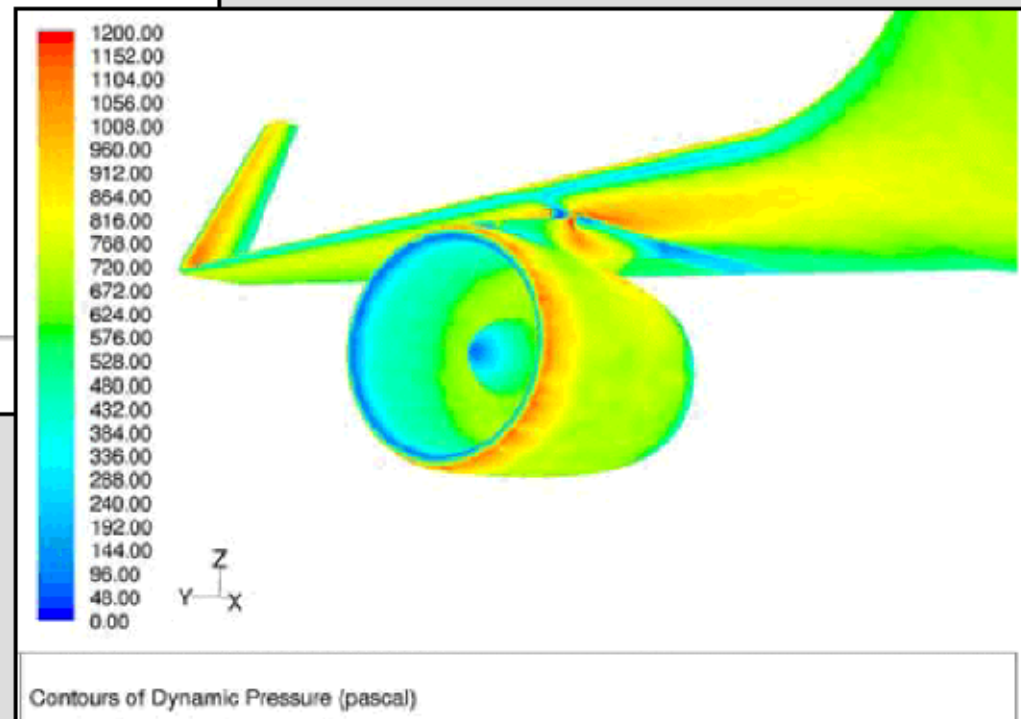



Aerodynamics



Hochschule für Angewandte
Wissenschaften Hamburg
Hamburg University of Applied Sciences

AC20.30: CFD with FLUENT

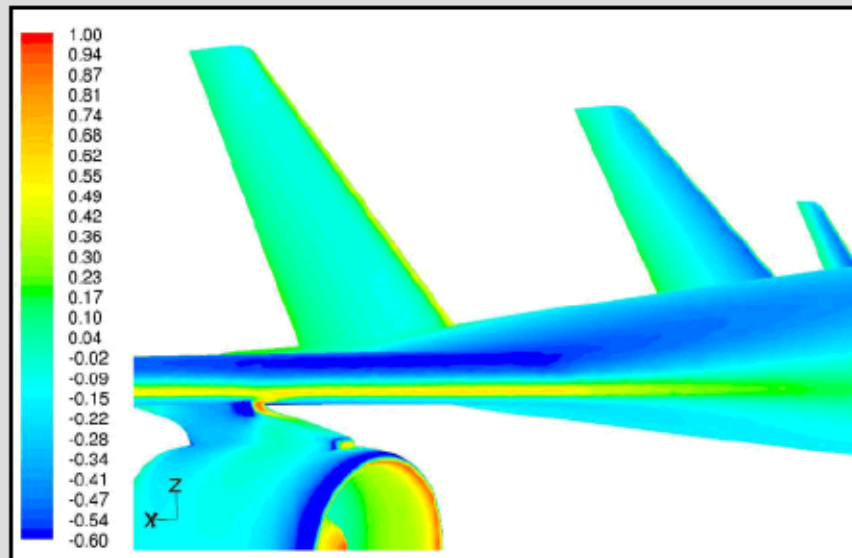

Fin Integration:

The fins experience a **cross flow**
at an angle of $3^\circ \dots 5^\circ$.
An optimized fin setting could reduce drag.

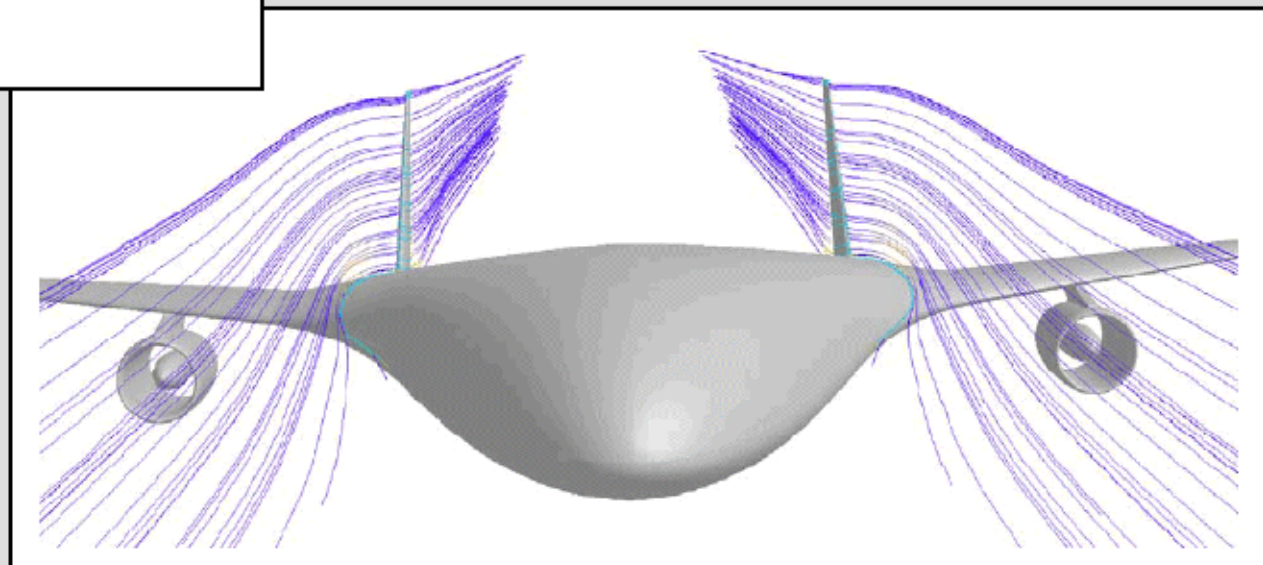



Aerodynamics

AC20.30: CFD with FLUENT

cruise, $\alpha = 1.2^\circ$

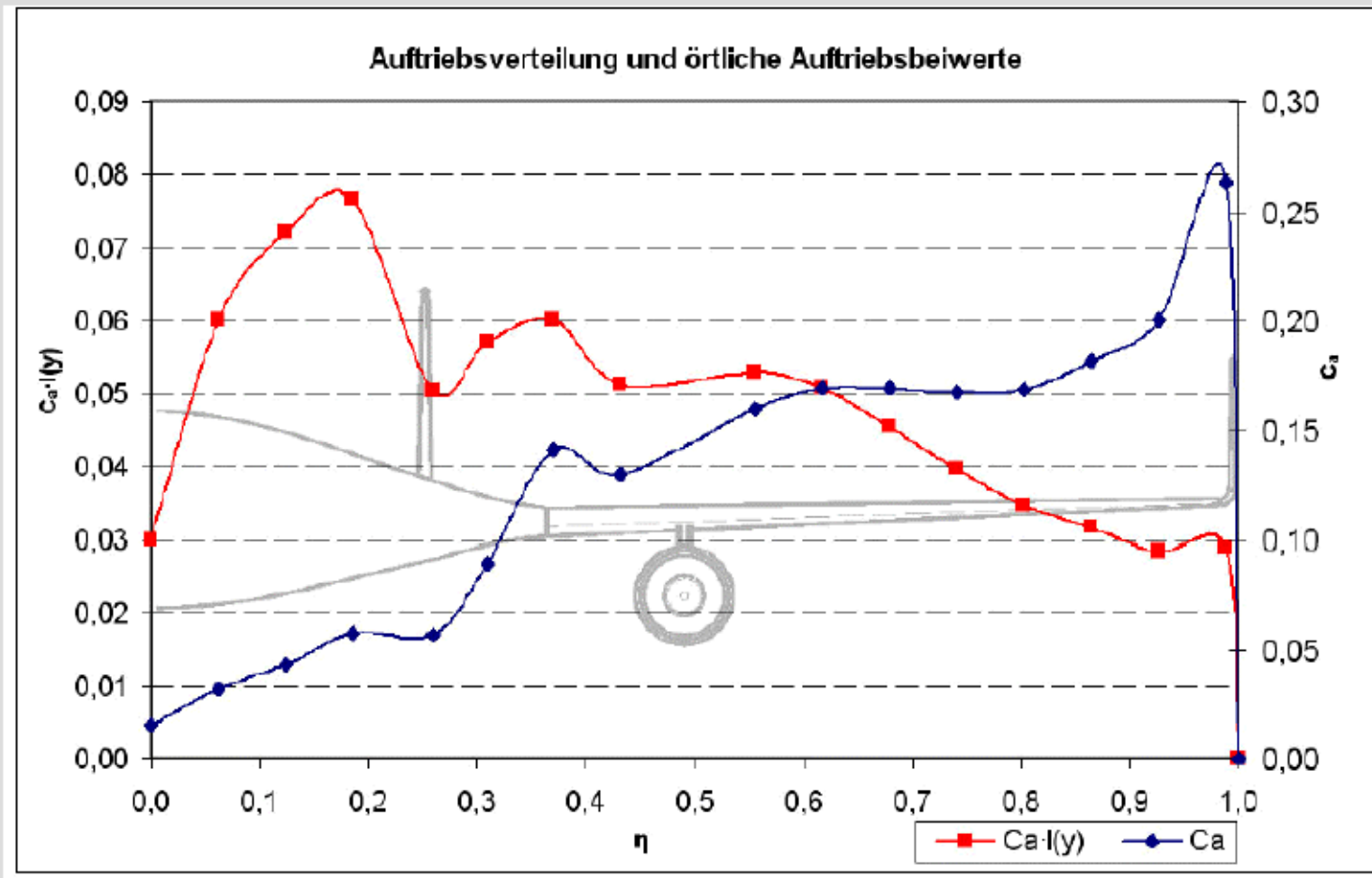

lift distribution / distribution of local lift coefficient



Flight Mechanics

Static Longitudinal Stability Fundamentals

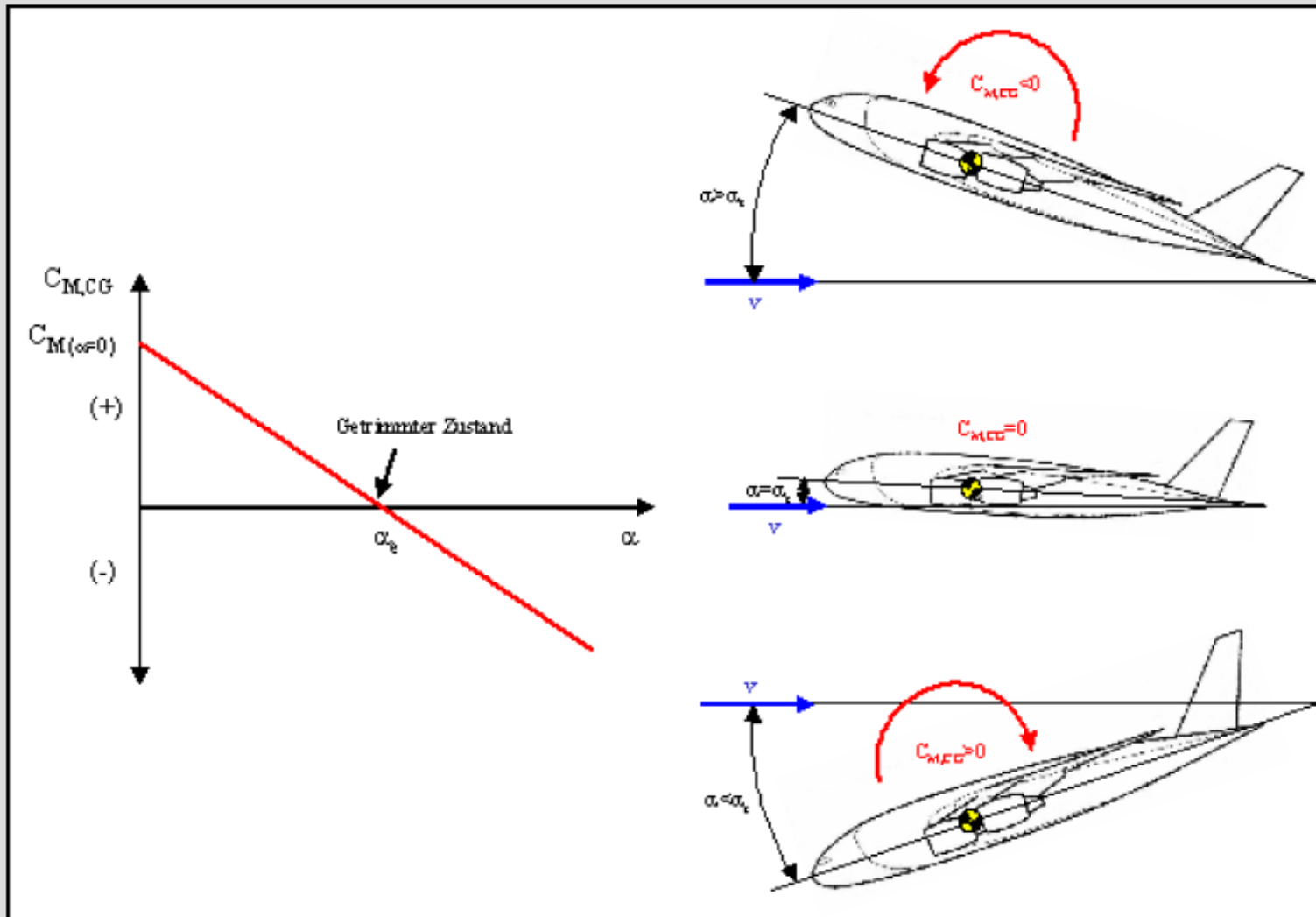



Flight Mechanics

Certification Requirements

CERTIFICATION SPECIFICATIONS, CS-25.173 Static Longitudinal Stability:

(a) A **pull** must be required to obtain and maintain **speeds below** the specified **trim speed**, and a **push** must be required to obtain and maintain **speeds above** the specified **trim speed**.

hence for BWB:

A) Design to Requirements:

- 1.) Center of Gravity (CG) forward of Aerodynamic Center (AC).
- 2.) Pitching Moment at $C_L = 0$ has to be positive.

or

B) Change Requirements (???):

Unstable aircraft stabilized by flight control system.



Flight Mechanics



Hochschule für Angewandte
Wissenschaften Hamburg
Hamburg University of Applied Sciences

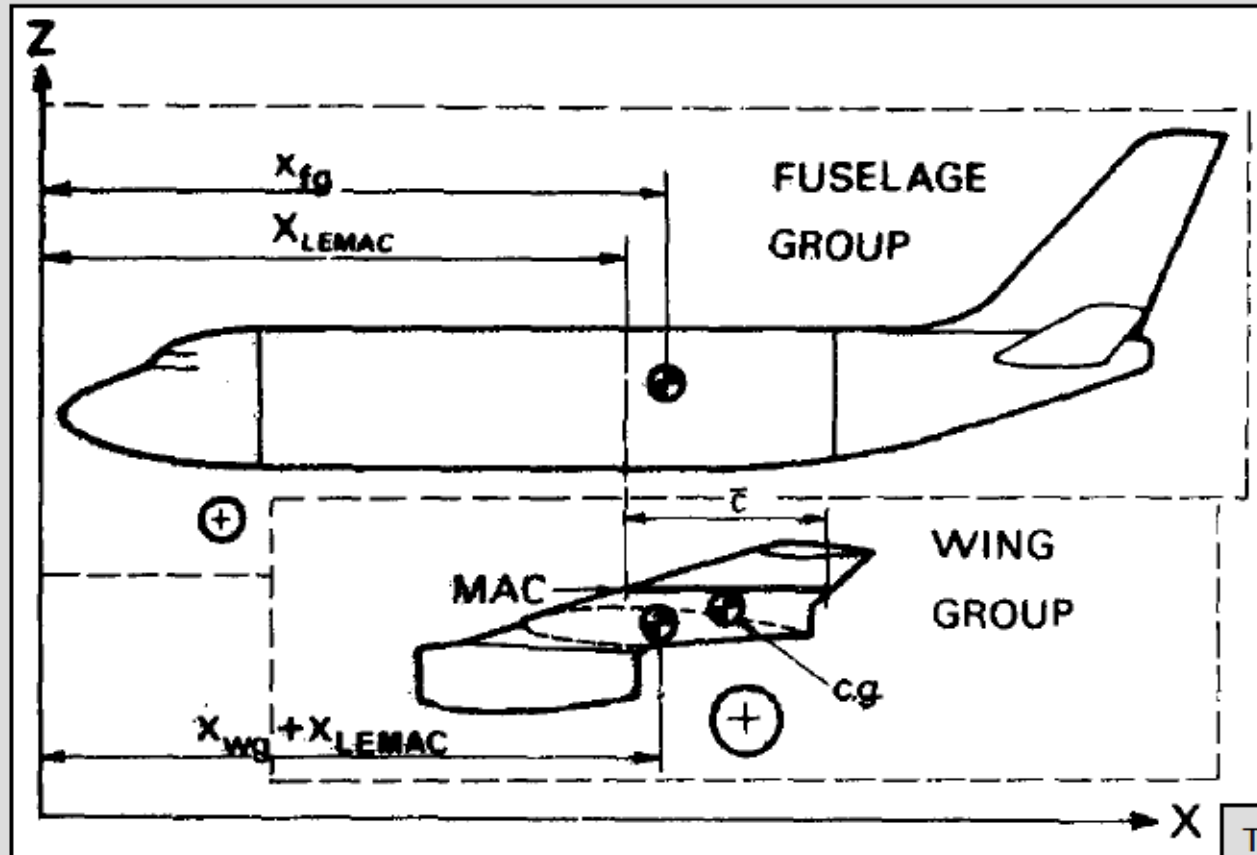

Positioning of the CG on the Mean Aerodynamic Chord (MAC) for required static margin is achieved in conventional design by **shifting the wing with respect to the fuselage. **This approach is not possible in BWB design!****

TORENBEEK, E.:
"Synthesis of Subsonic
Airplane Design".
Delft : Delft University Press,
1988

$$x_{LEMAC} = x_{fg} - x_{cg} + \frac{m_{wg}}{m_{fg}} (x_{wg} - x_{cg})$$



Flight Mechanics

Static Longitudinal Stability for BWB Configurations

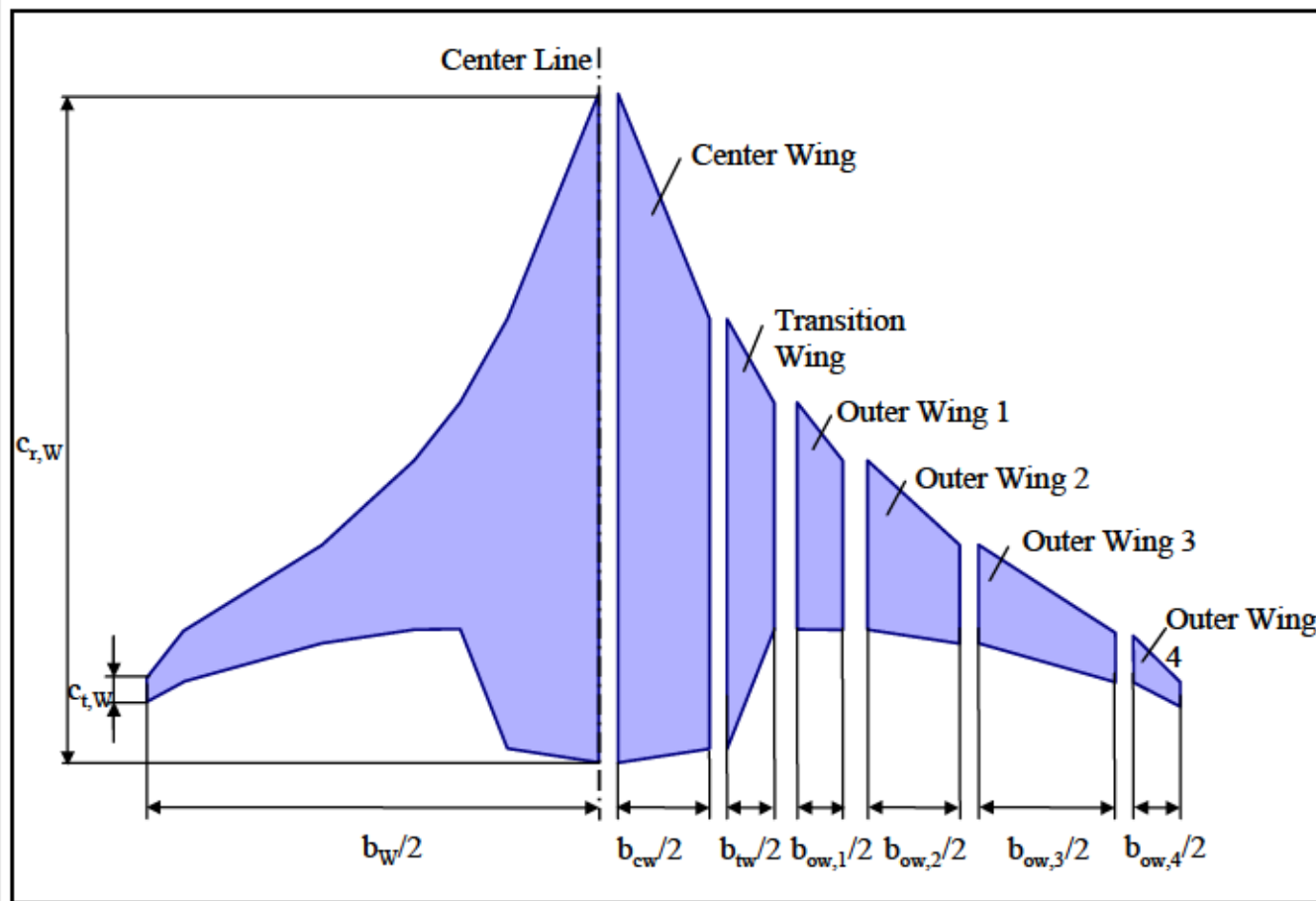

F. Bansa, Diplomarbeit,
Hamburg University of
Applied Sciences

A BWB can be designed for static longitudinal stability with an interactive EXCEL-based program. The program assumes the BWB to consist of a maximum of 6 different wing trapezoids.



Flight Mechanics

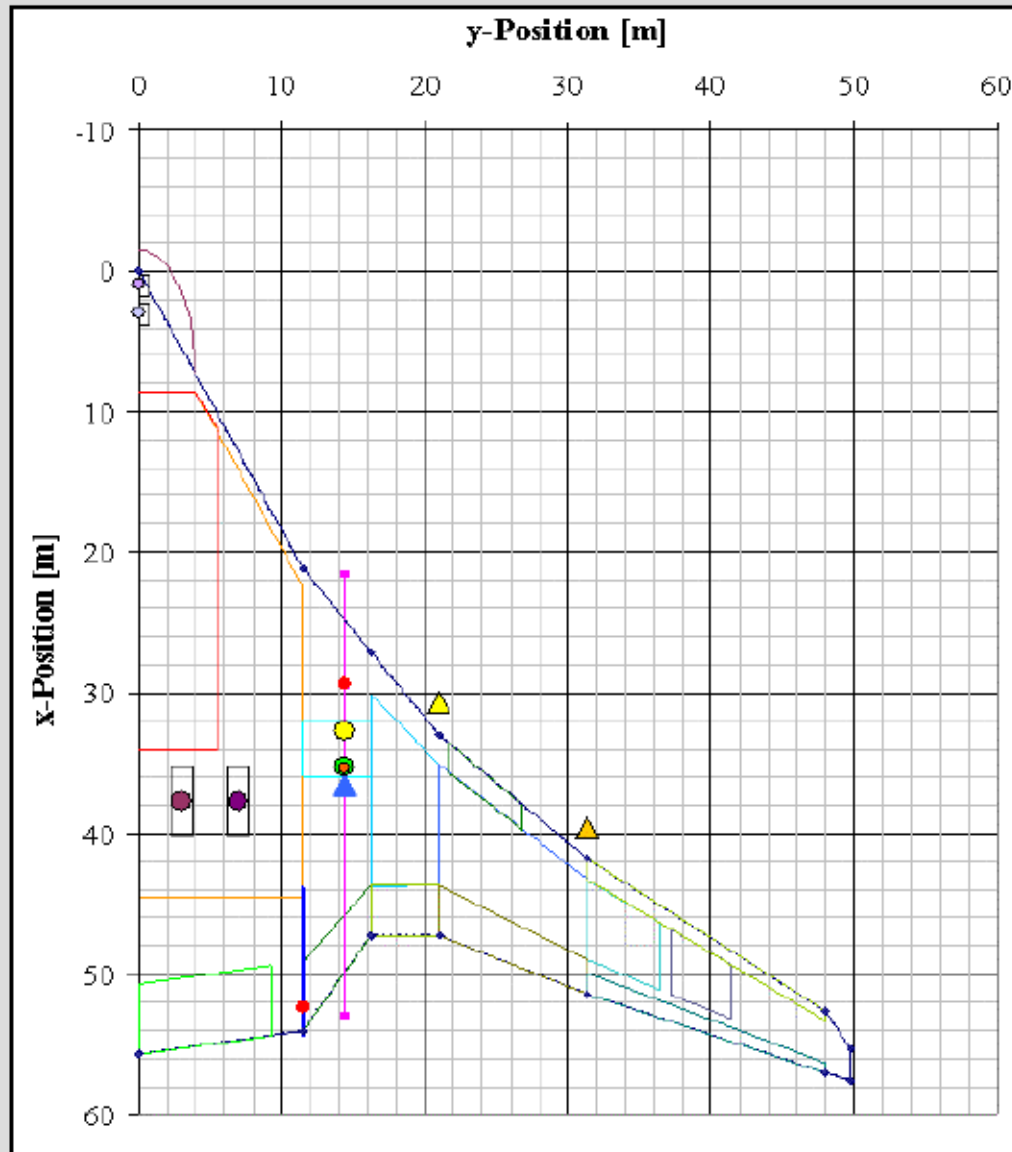

Interactive parameter variation to find a suitable static margin for BWB configurations by calculation of:

- 1.) center of gravity, CG
- 2.) aerodynamic center, AC.

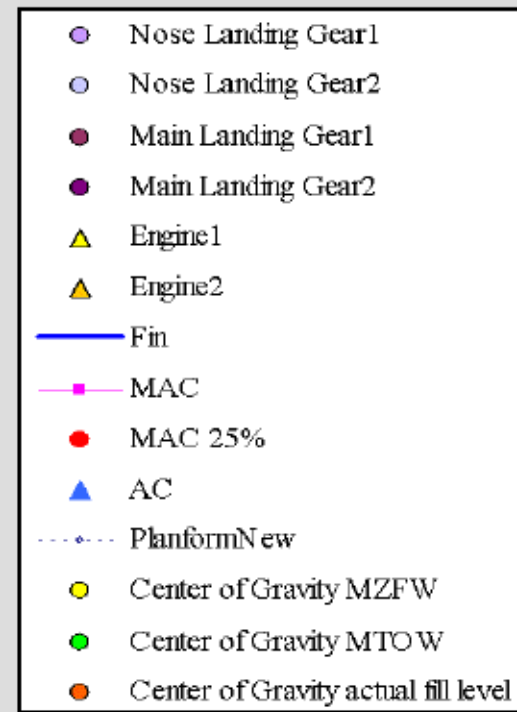



Flight Mechanics

Static Longitudinal Stability for VELA Configurations

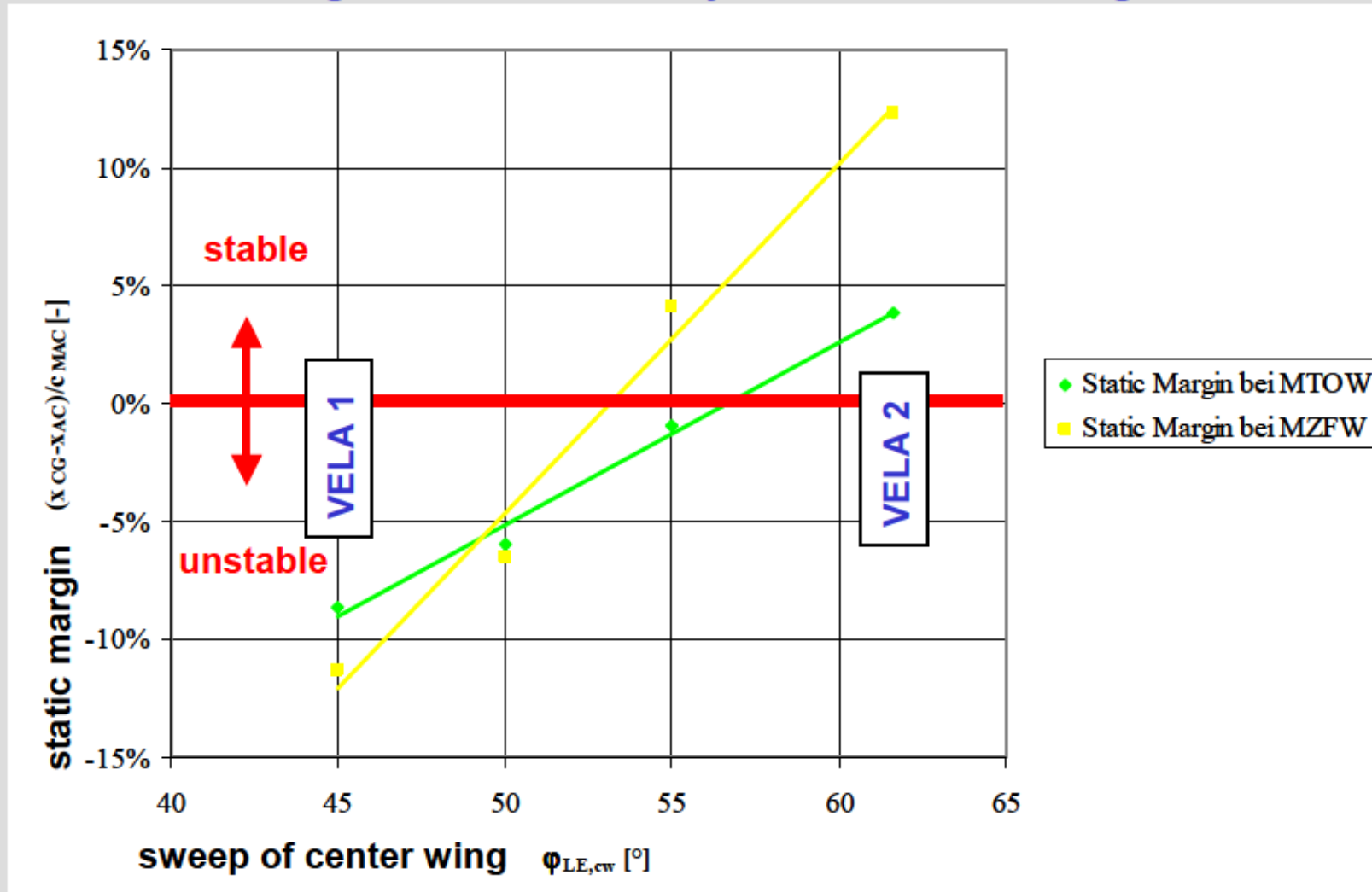



Flight Mechanics



Hochschule für Angewandte
Wissenschaften Hamburg
Hamburg University of Applied Sciences

Static Longitudinal Stability for Boeing BWB Configurations

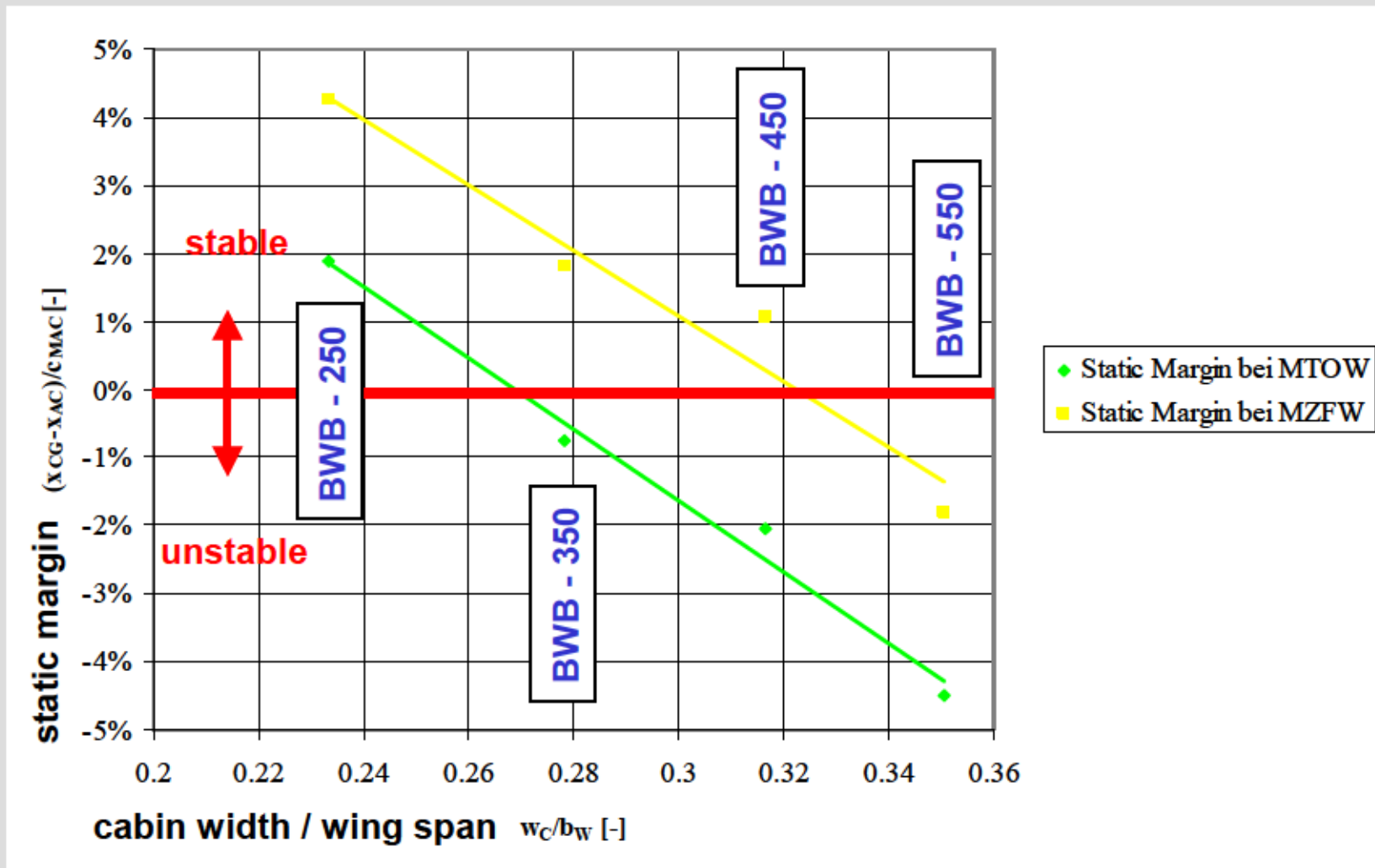



Structures

Weight Saving Potential of BWB Configurations

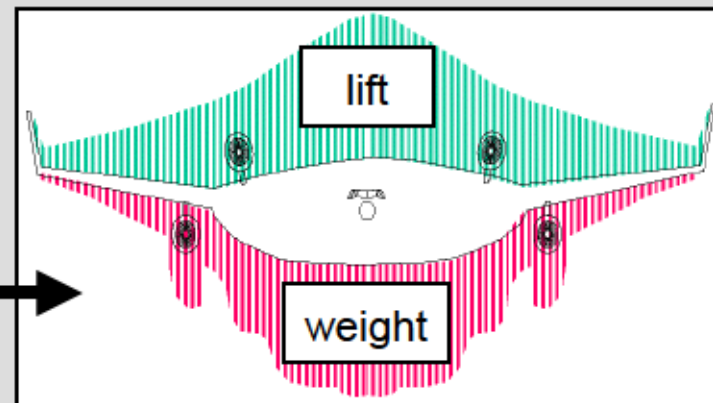
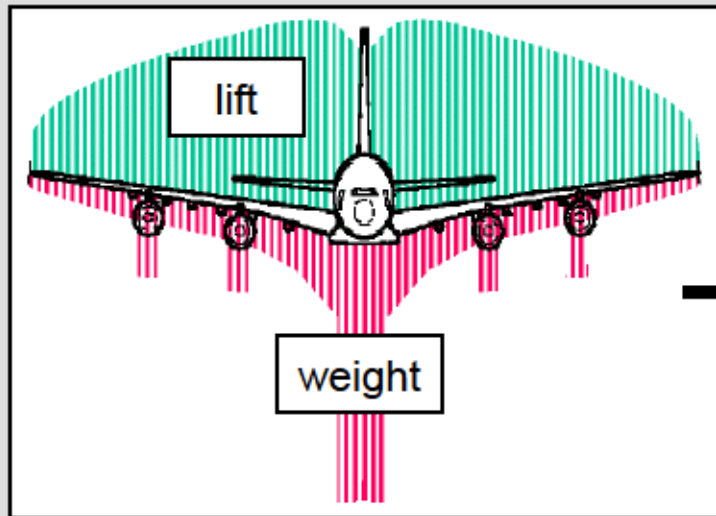

Less bending moments in a flying wing or BWB

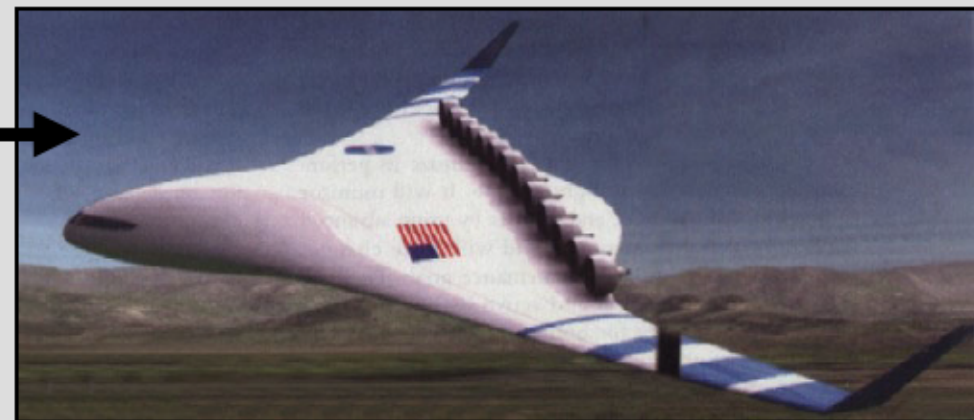

BWB study with distributed propulsion (Virginia Polytechnic)

Helios - example of an extreme span loader with distributed propulsion (NASA / AeroVironment, Inc.)



Structures

VELA 2 - Basic Structural Layout

T. Kumar Turai, Master Thesis,
Hamburg University of Applied Sciences

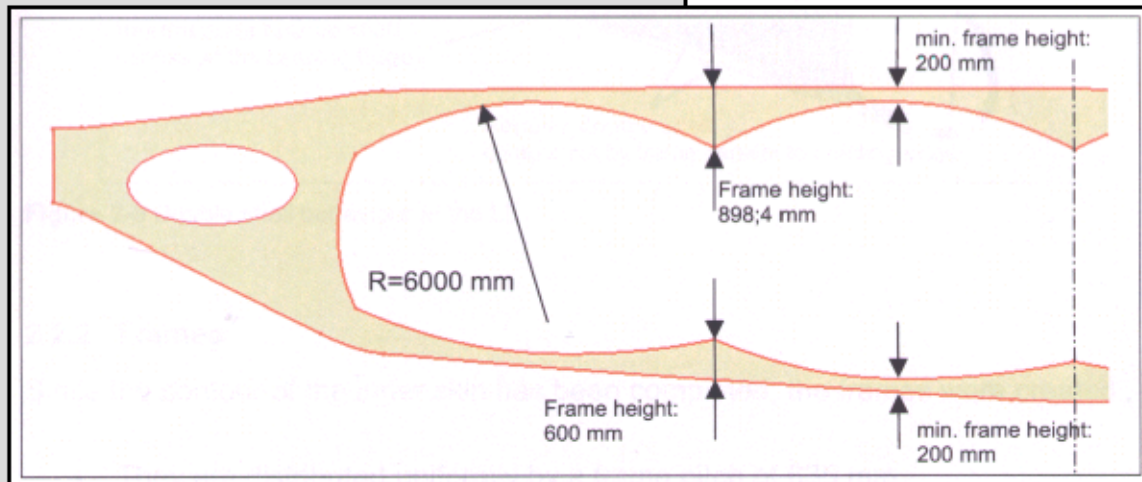
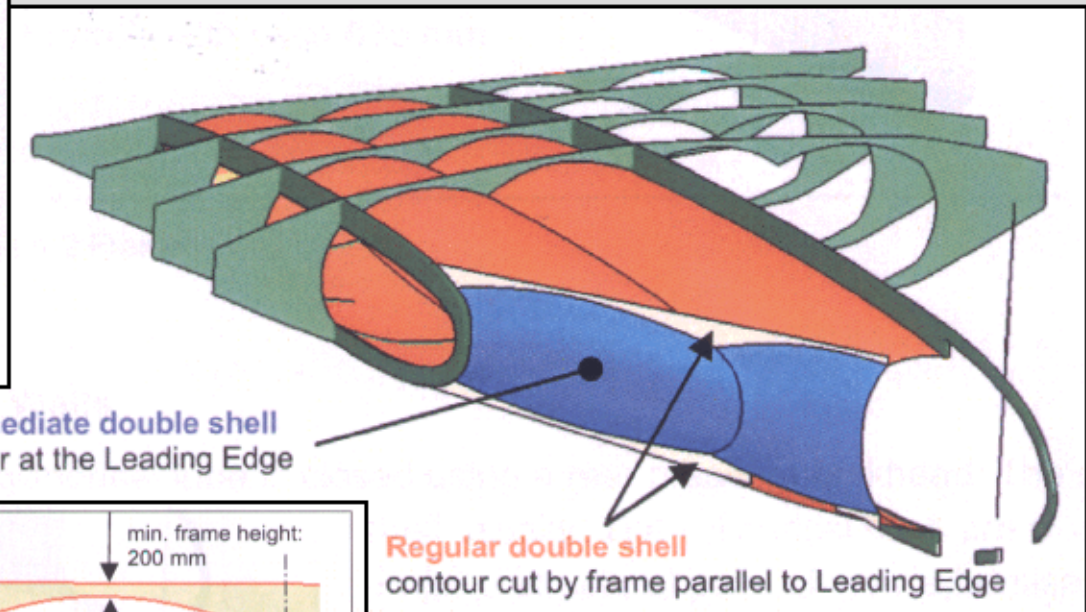
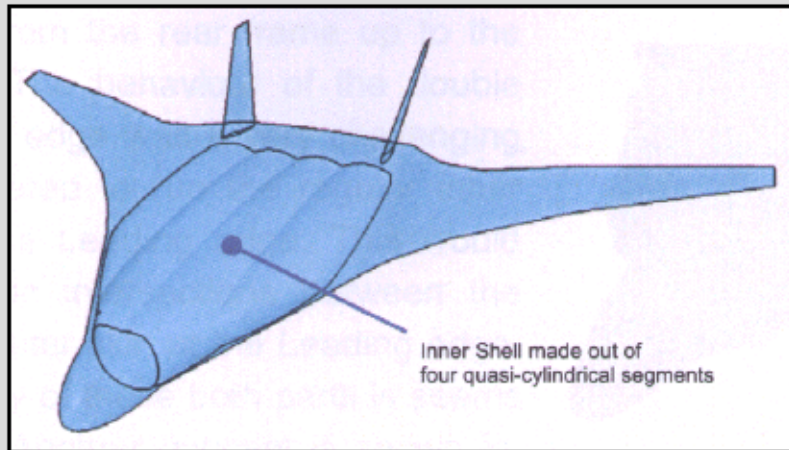



Structures



Hochschule für Angewandte
Wissenschaften Hamburg
Hamburg University of Applied Sciences

VELA 2 - Cabin

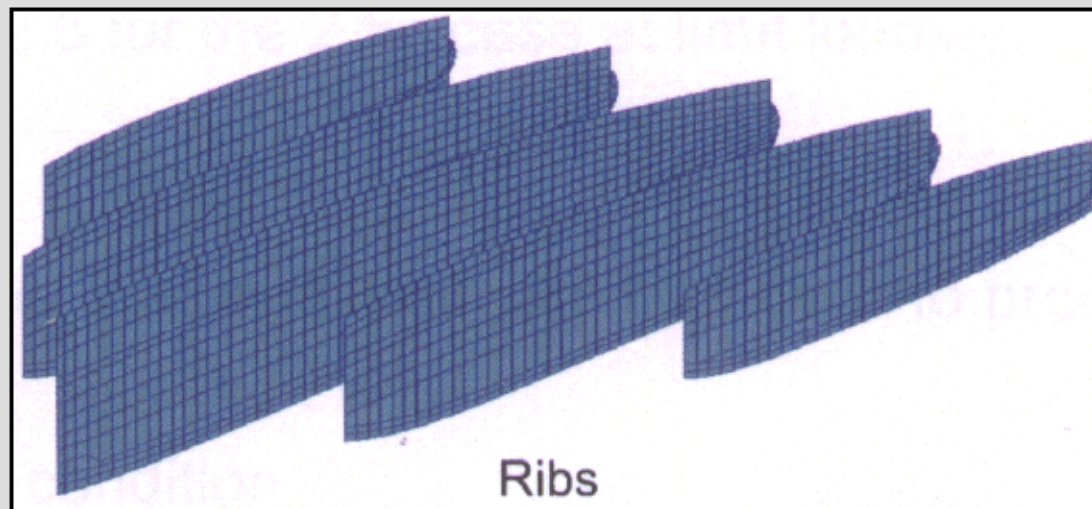
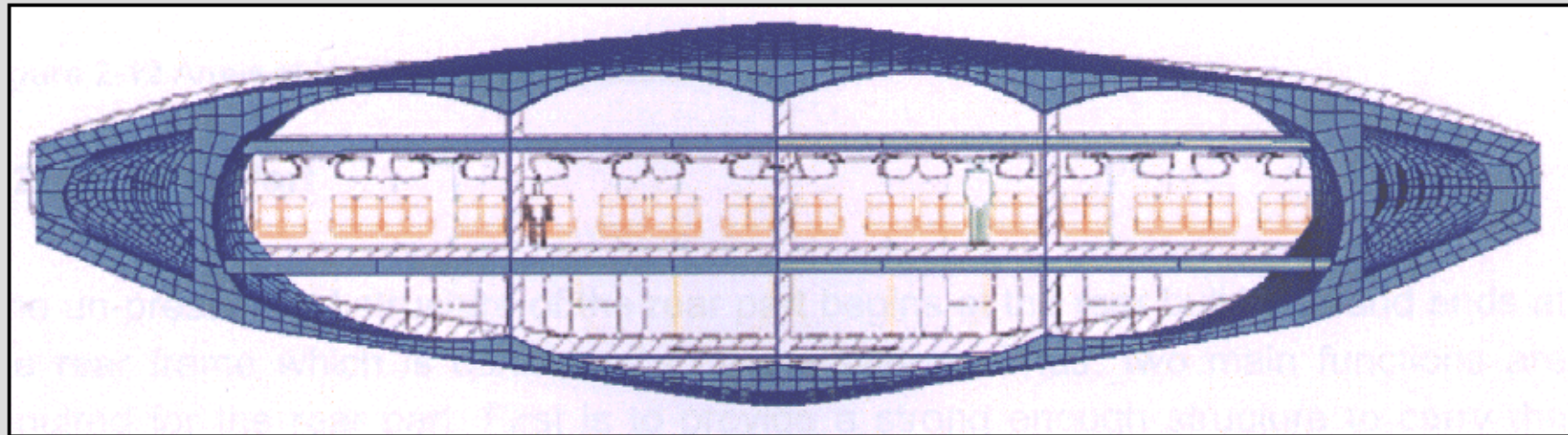



Structures



Hochschule für Angewandte
Wissenschaften Hamburg
Hamburg University of Applied Sciences

VELA 2 - Wing Integration

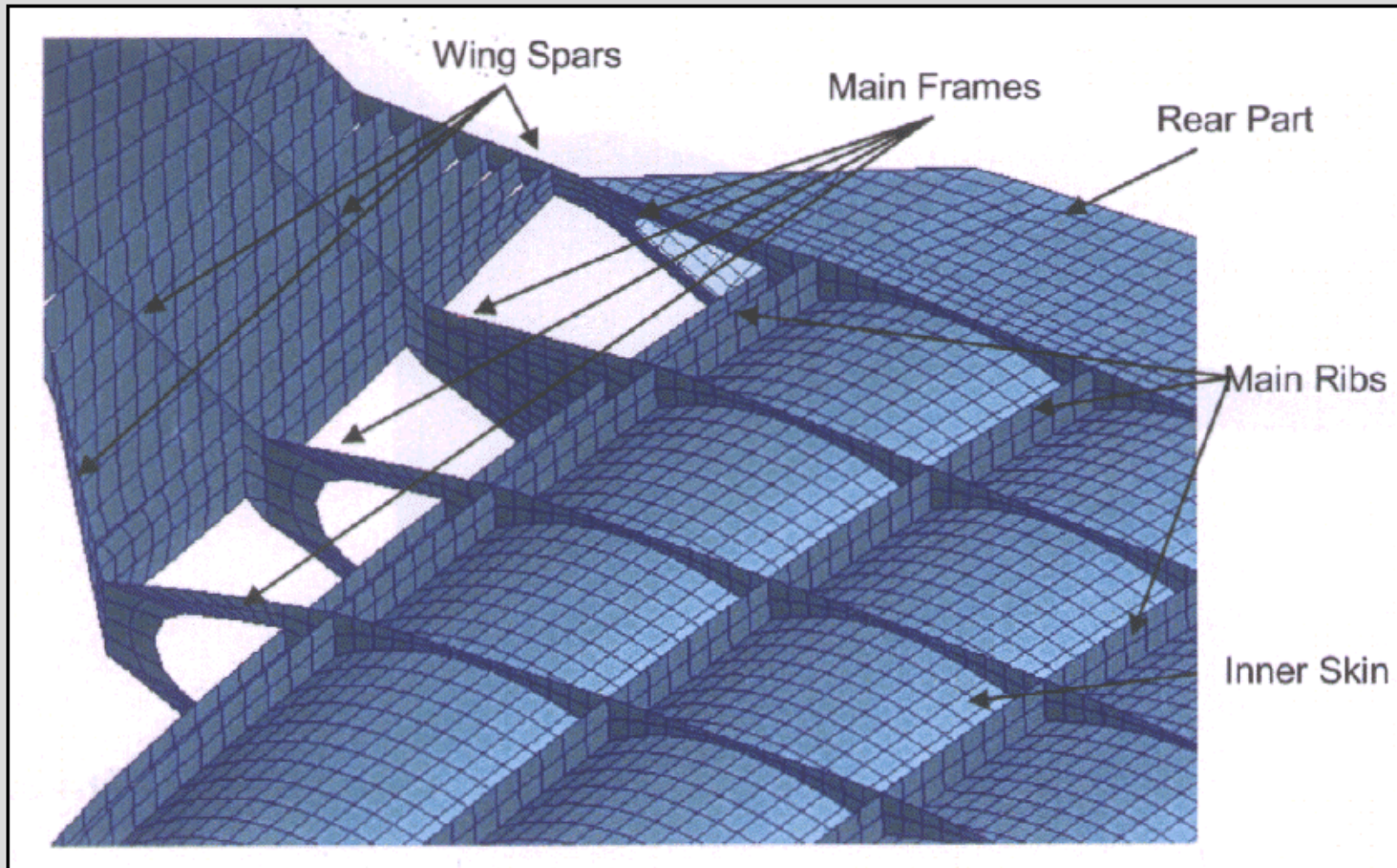



Structures

VELA 2 - Floor Integration

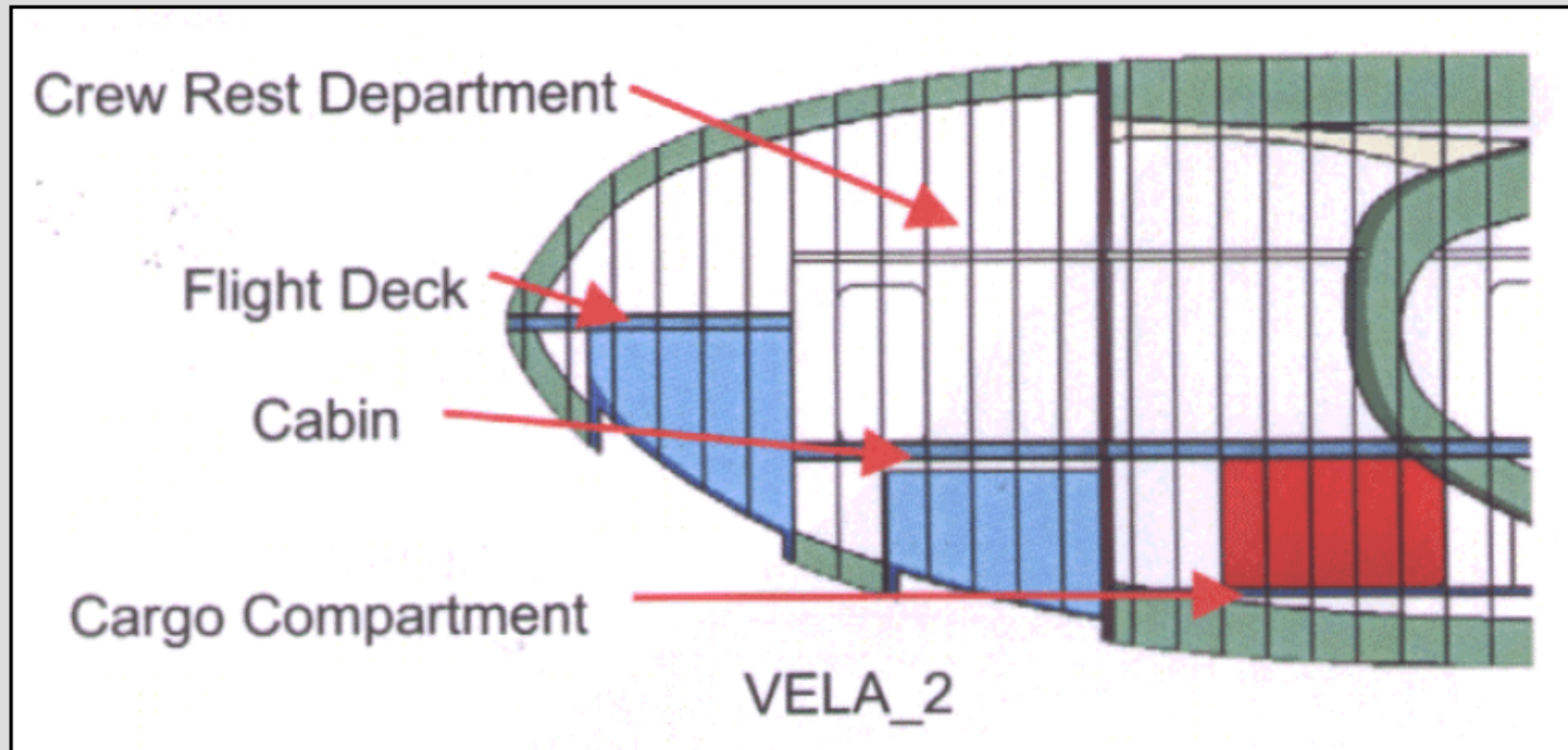



Structures



Hochschule für Angewandte
Wissenschaften Hamburg
Hamburg University of Applied Sciences

VELA 2 - Doors

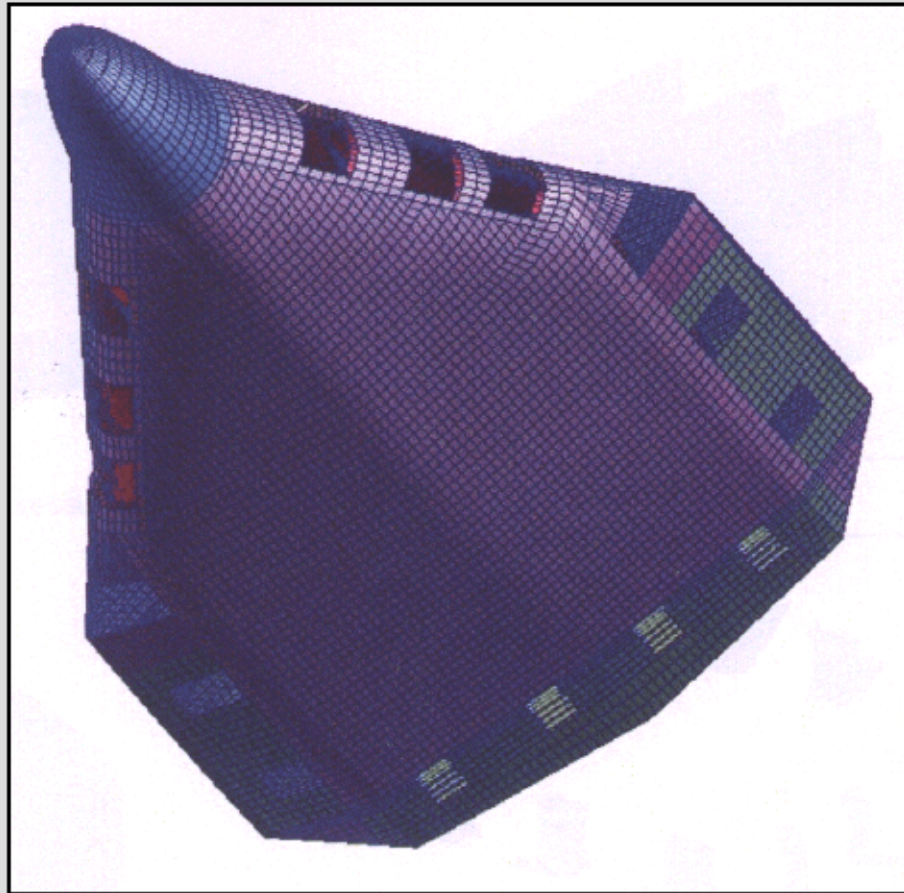

Door cut-outs

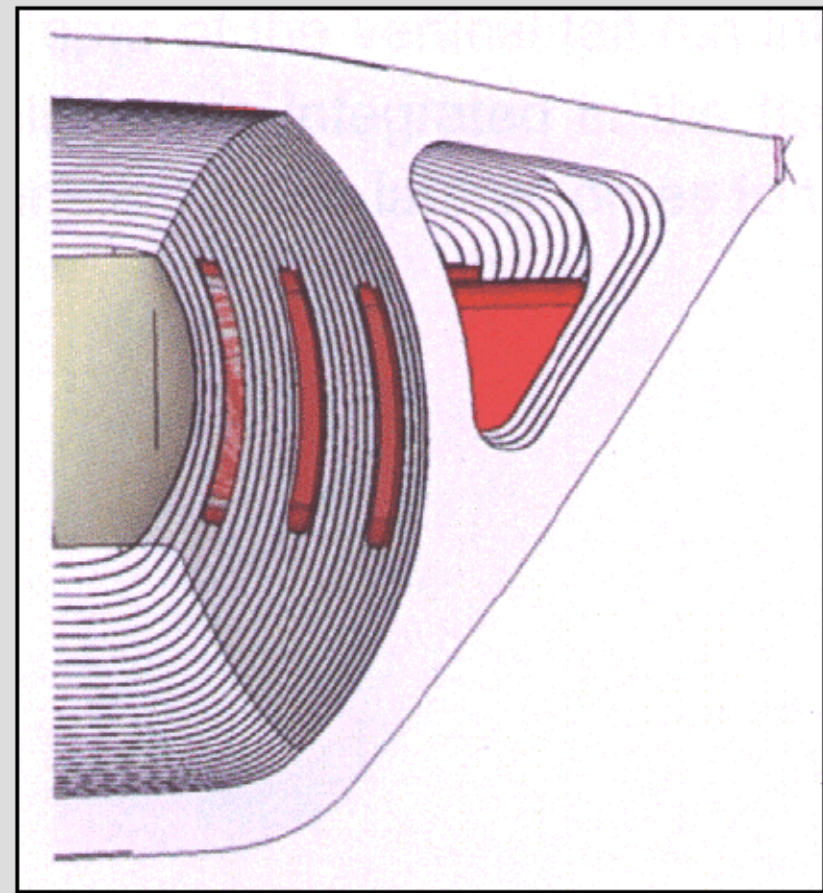

Side door integration



Structures



Hochschule für Angewandte
Wissenschaften Hamburg
Hamburg University of Applied Sciences

VELA 2 - Fin Integration

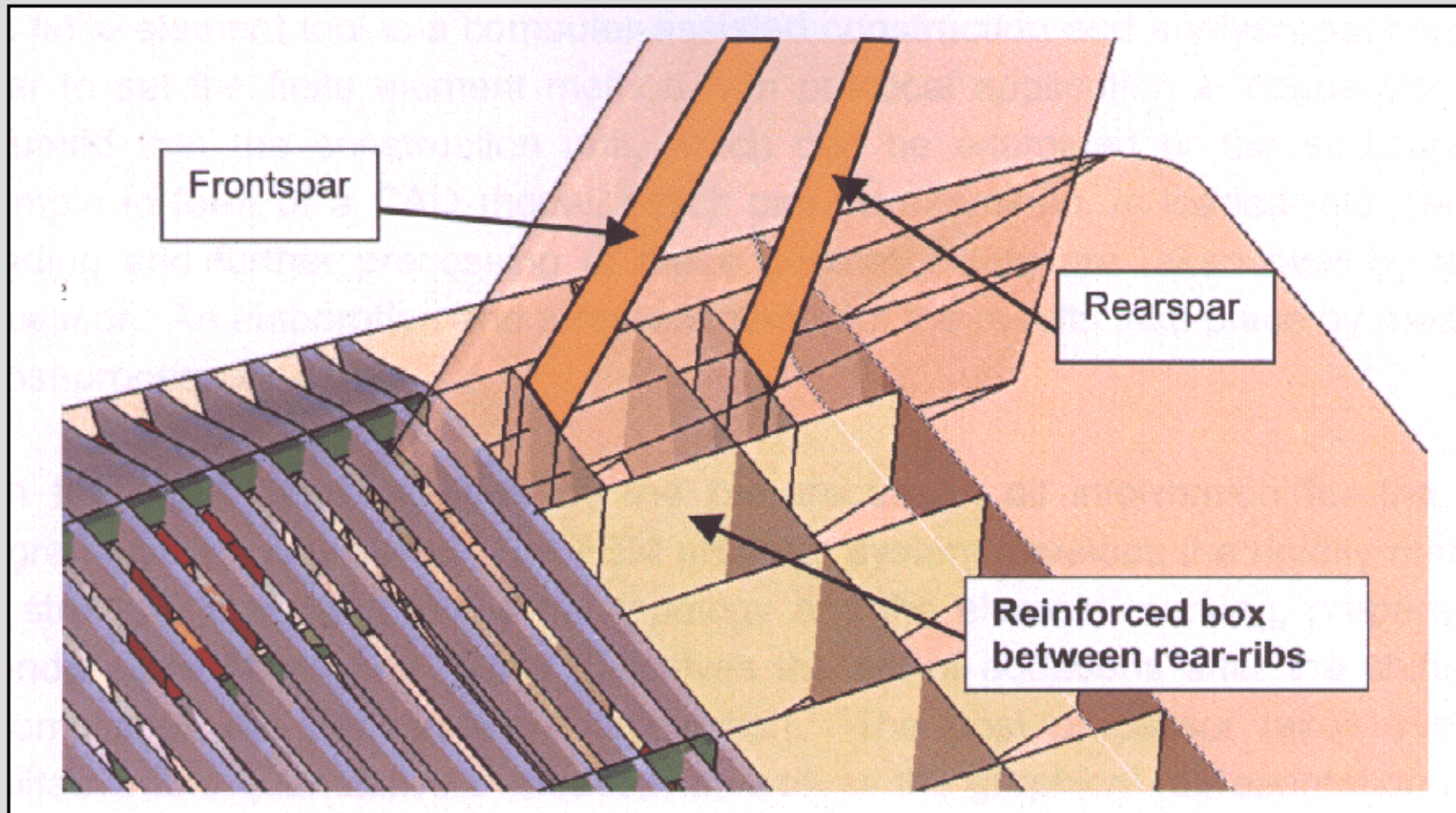



Structures



Hochschule für Angewandte
Wissenschaften Hamburg
Hamburg University of Applied Sciences

VELA 2 - Rear Pressure Bulkhead

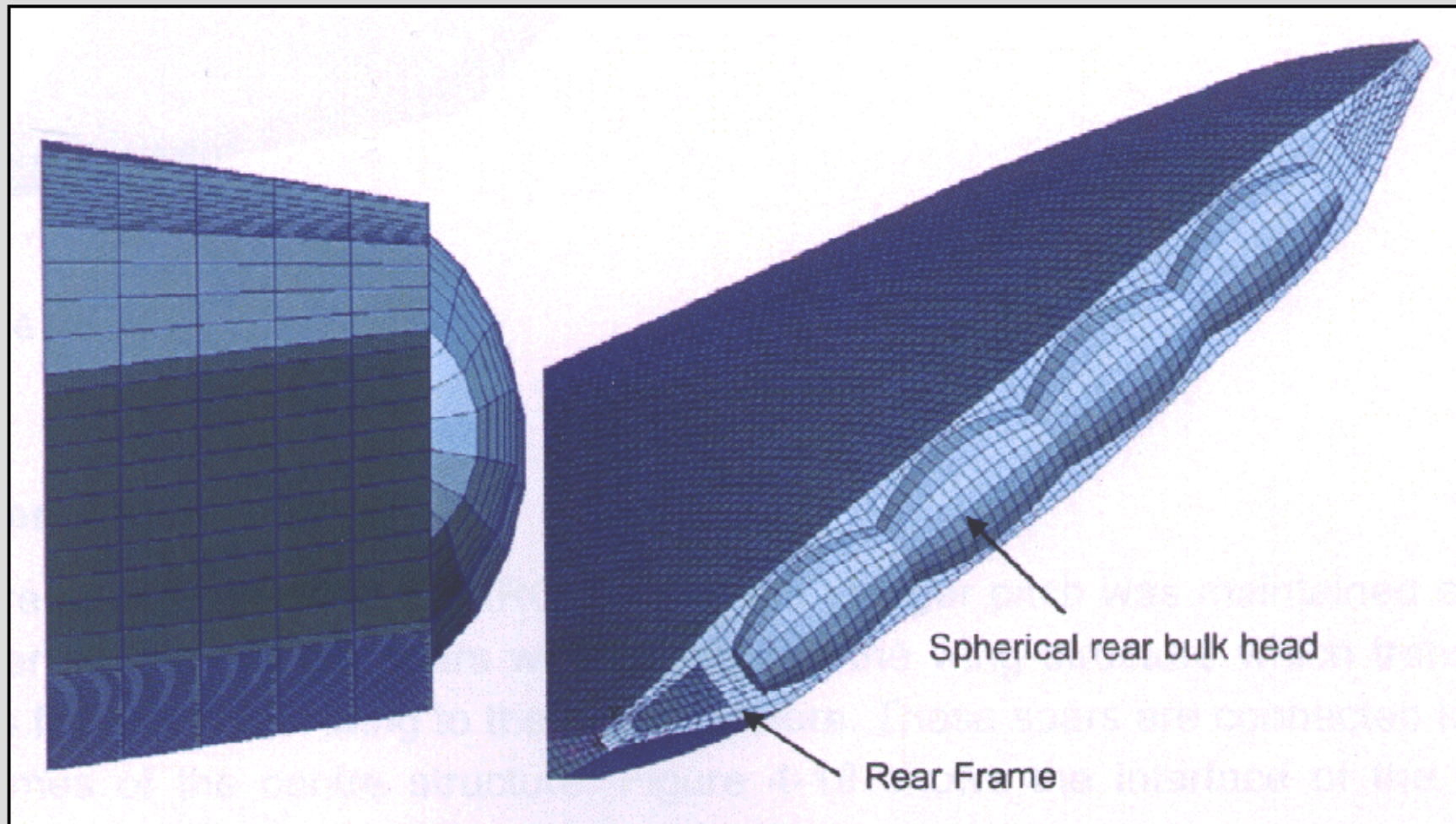



Mass Prediction

VELA 2

Weight Chapter	F. Bansa	T. Kumar Turai	T. Kumar Turai (FEM)
10 Structure	234669 kg	253529 kg	210070 kg
20 Power Units	37731 kg	36603 kg	->
30/40 Systems	19795 kg	23302 kg	->
50 Furnishings	35313 kg	27588 kg	->
60 Operator Items	35313 kg	39578 kg	->
OWE	362820 kg	380600 kg	337141 kg
OWE/MTOW	0.525	0.551	0.488
Loftin	0.521		
Marckwardt	0.462		
A380-800	0.501		
A340-600	0.475		
Taken for Preliminary Sizing: 0.500			
Result: The BWB design does not significantly improve the OWE/MTOW ratio!			
Latest News: One-shell layout can lead to OWE/MTWO = 0.44 ... 0.46 !			



System Integration



Hochschule für Angewandte
Wissenschaften Hamburg
Hamburg University of Applied Sciences

VELA 2 - ATA 21 - Temperature Control & Ventilation

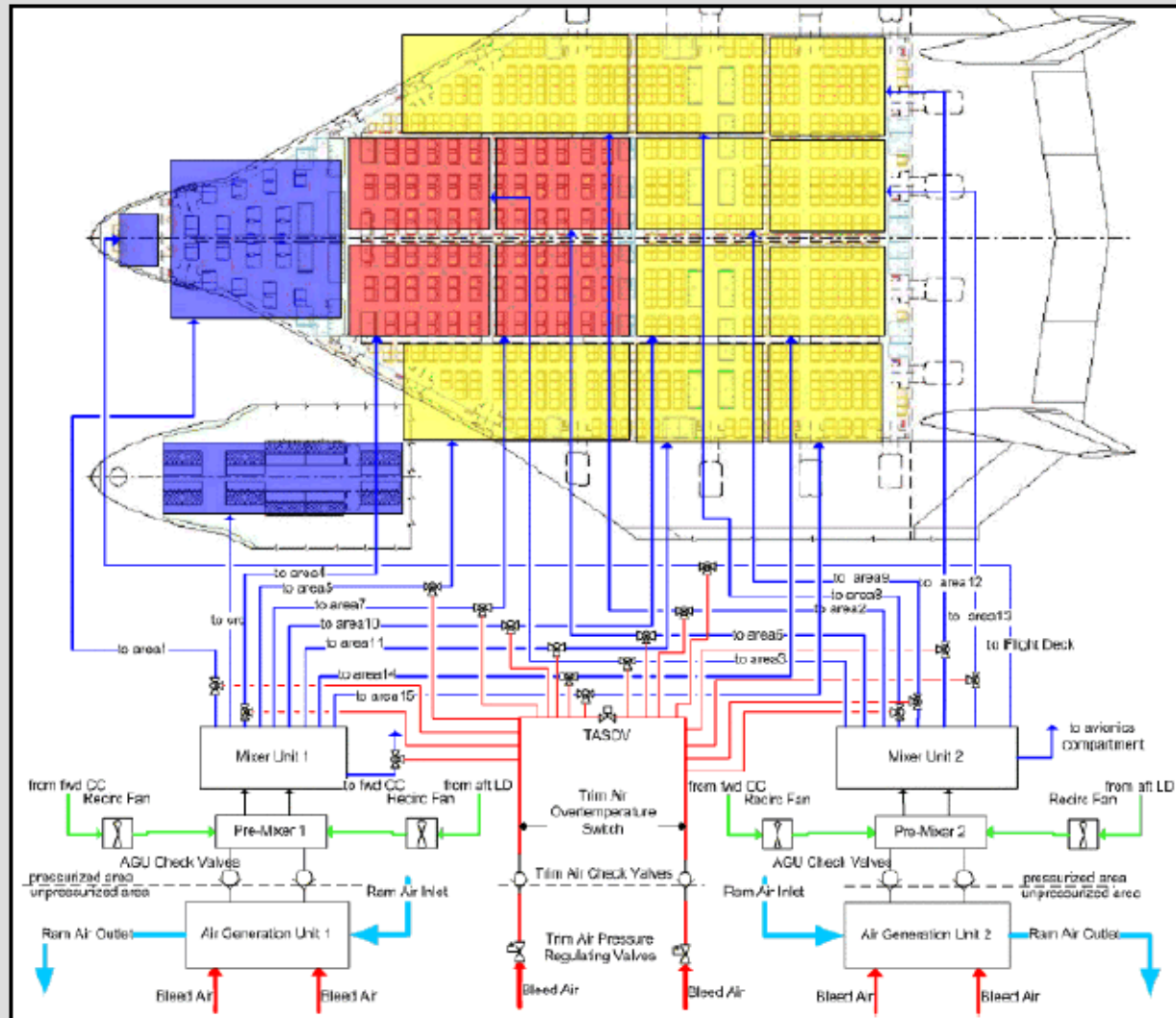

M. Mahnken, Diplomarbeit,
Hamburg University of
Applied Sciences

Steps in system
integration:

- 1.) System diagram
- 2.) Sizing
- 3.) Routing & ducting



System Integration



Hochschule für Angewandte
Wissenschaften Hamburg
Hamburg University of Applied Sciences

VELA 2 - ATA 21 - Pack Sizing

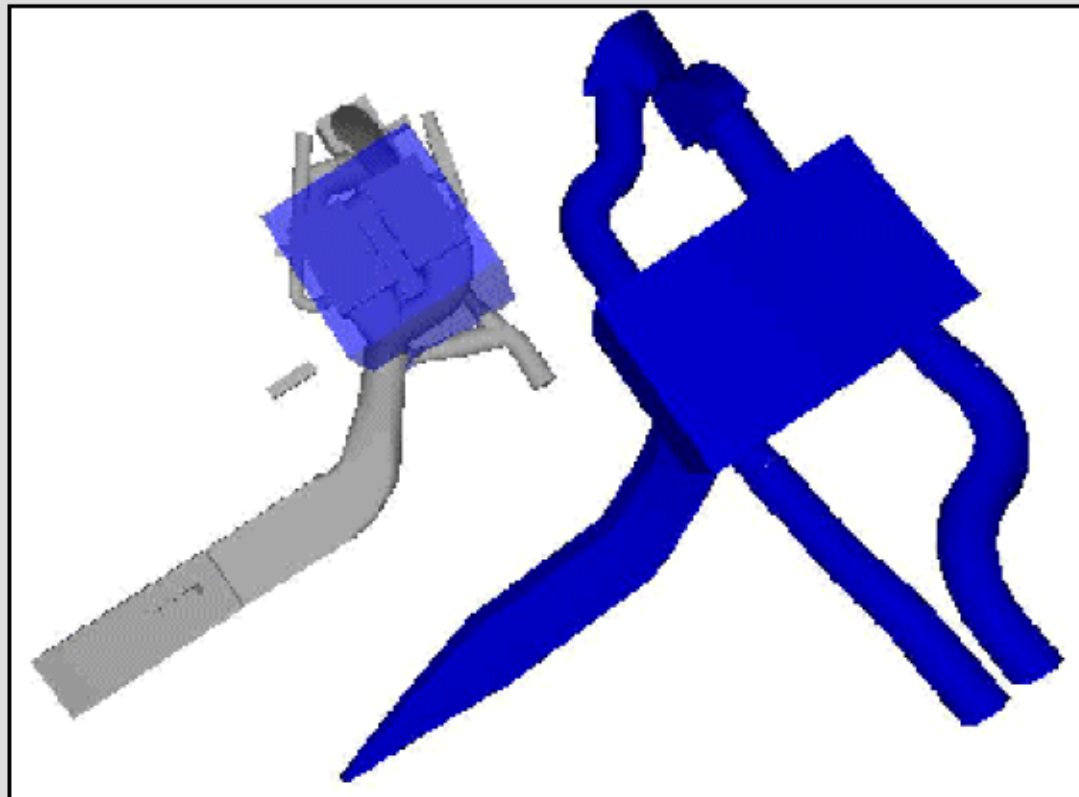

Air Generation Unit (pack): A380 and VELA 2

Steps in system
integration:

- 1.) System diagram
- 2.) Sizing
- 3.) Routing & ducting



System Integration



Hochschule für Angewandte
Wissenschaften Hamburg
Hamburg University of Applied Sciences

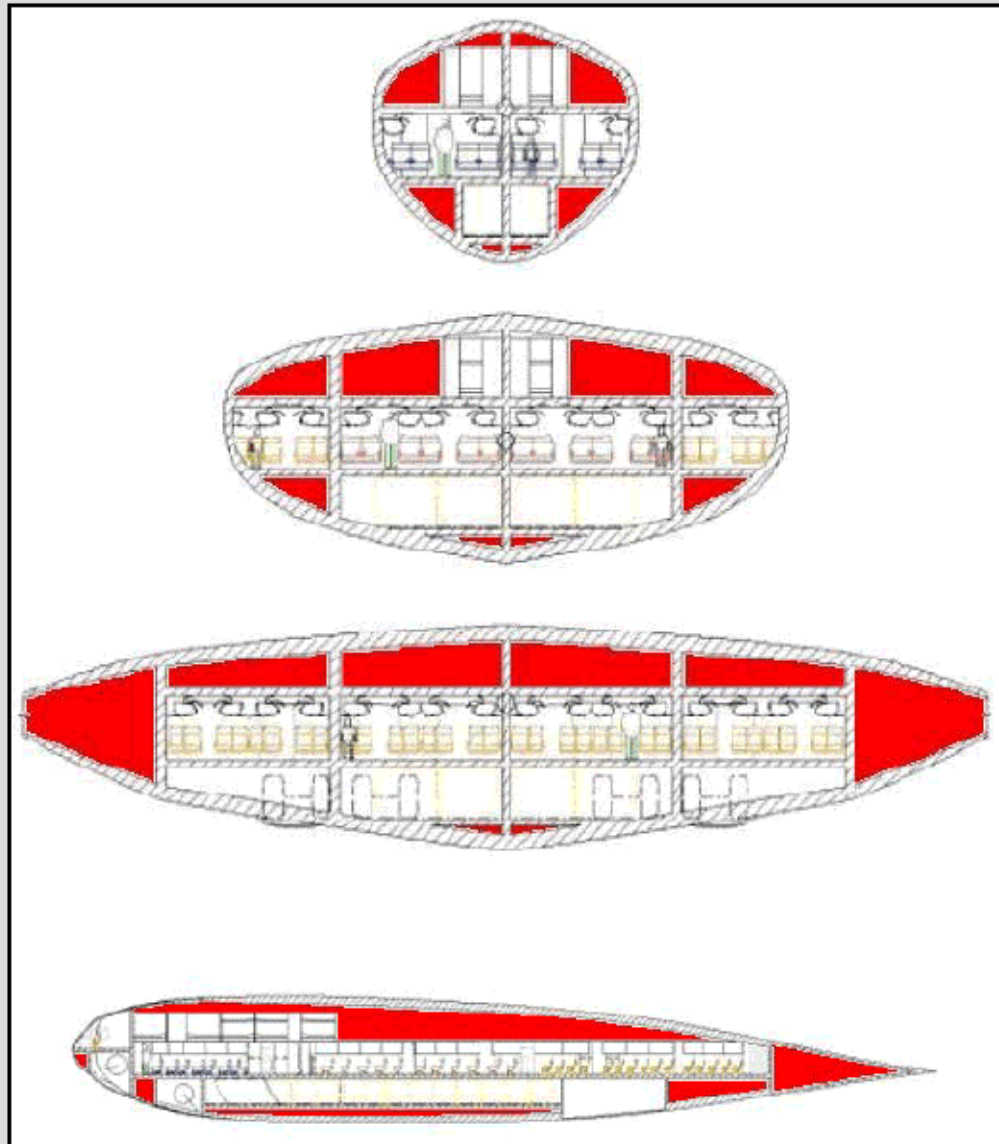

VELA 2 - System Installation Areas

Steps in system
integration:

- 1.) System diagram
- 2.) Sizing
- 3.) Routing & ducting



System Integration



Hochschule für Angewandte
Wissenschaften Hamburg
Hamburg University of Applied Sciences

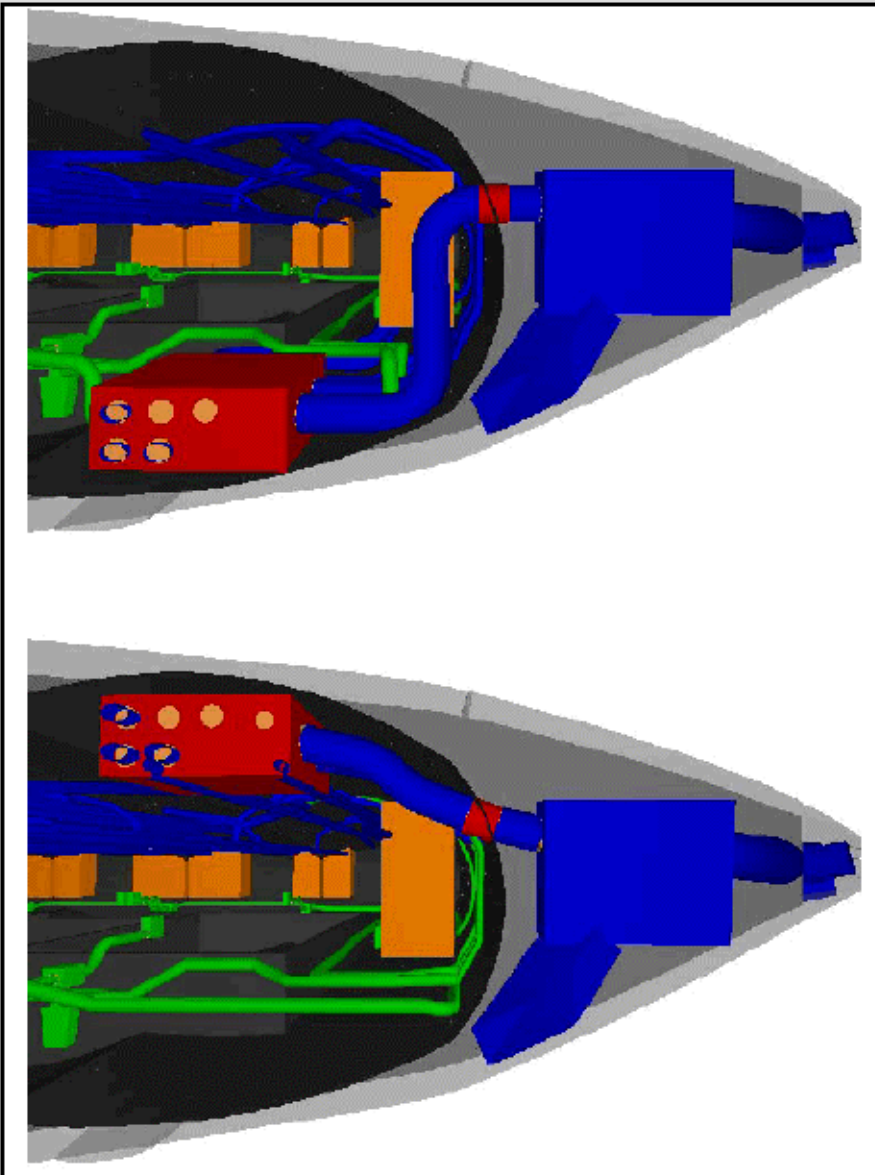

VELA 2 - ATA 21 - Positioning of the Mixing Unit

Steps in system
integration:

- 1.) System diagram
- 2.) Sizing
- 3.) Routing & ducting

Air Generation Unit is positioned in the transition wing.

Alternative position (above cabin) of the **Mixing Unit** eliminates riser ducts.

Ducts for recirculation air.



System Integration

VELA 2 - ATA 21 - Ducting

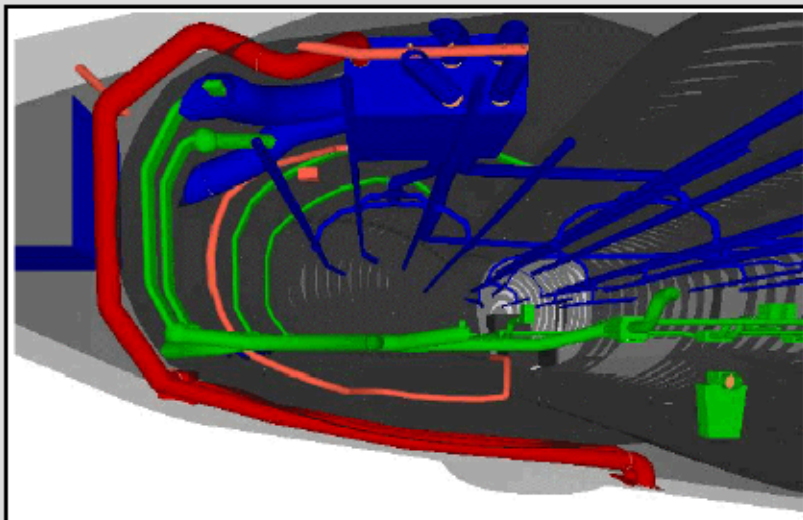
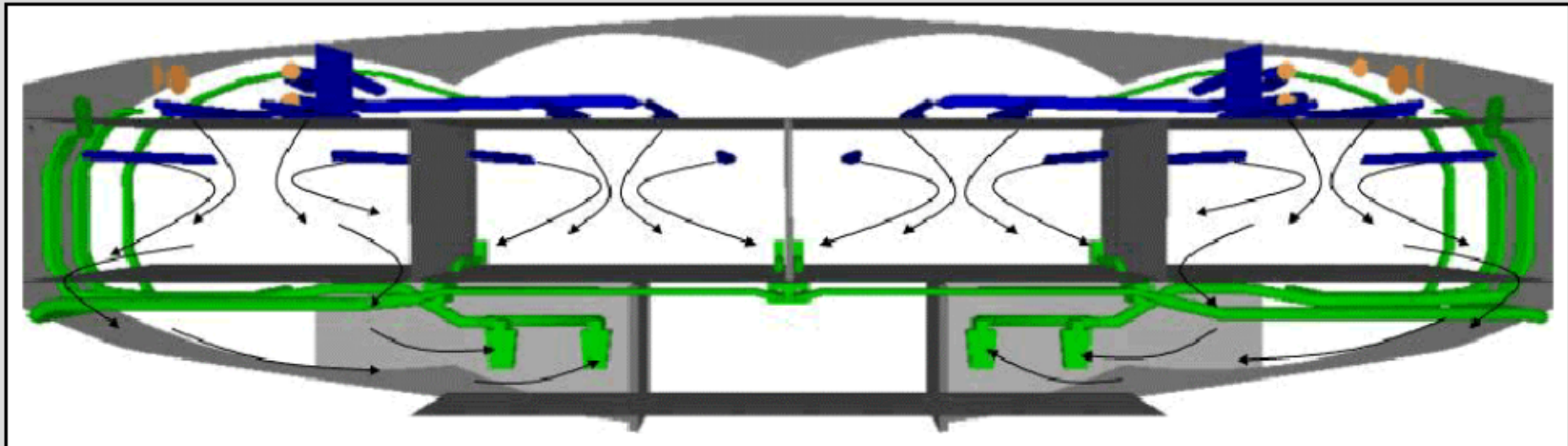

Air circulation. **Recirculation** requires **ducts**.

Low pressure air connector and duct to mixing unit.

Duct for emergency air.



VELA 2 - ATA 21 - Pressure Control

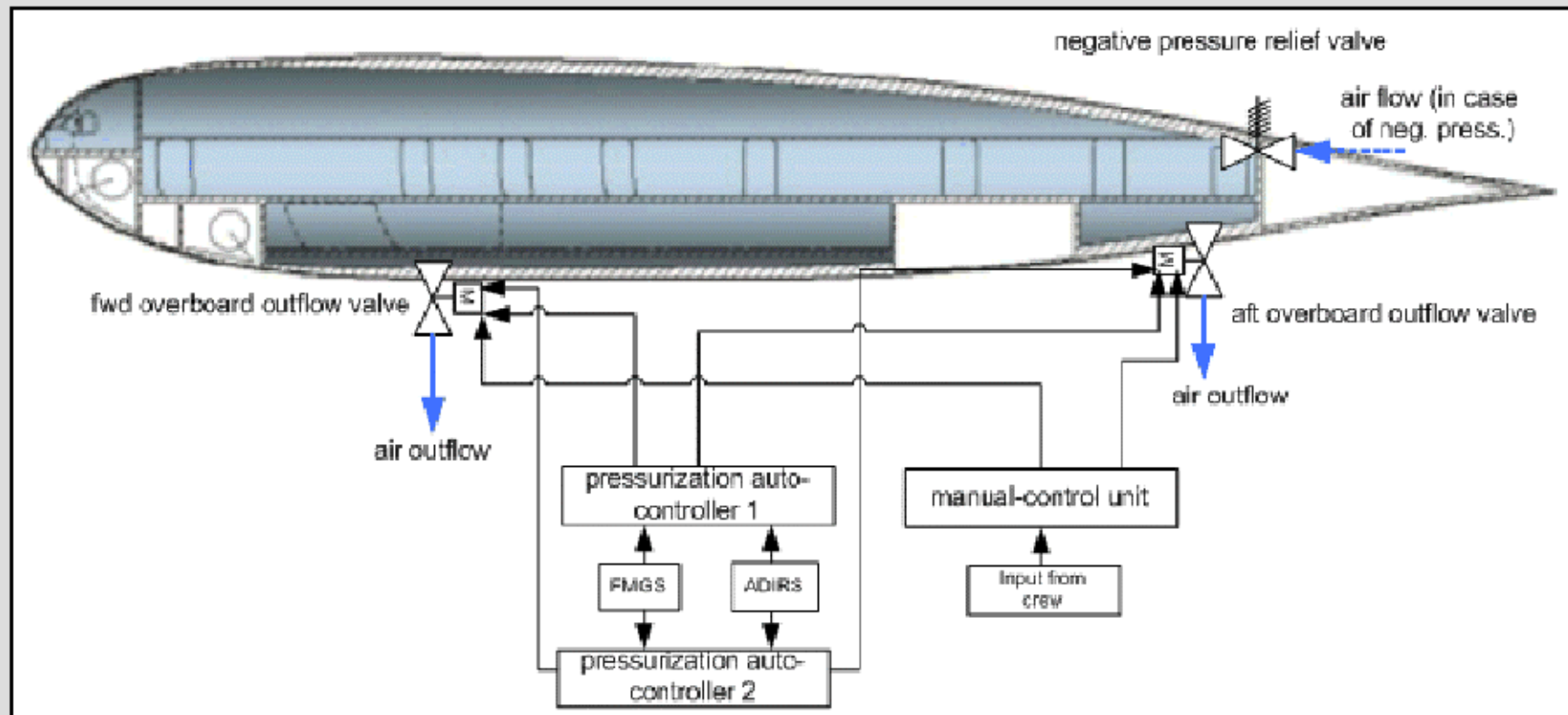

Steps in system integration:

- 1.) System diagram
- 2.) Sizing
- 3.) Routing & ducting



System Integration

VELA 2 - ATA 26 - Cargo Fire Suppression System

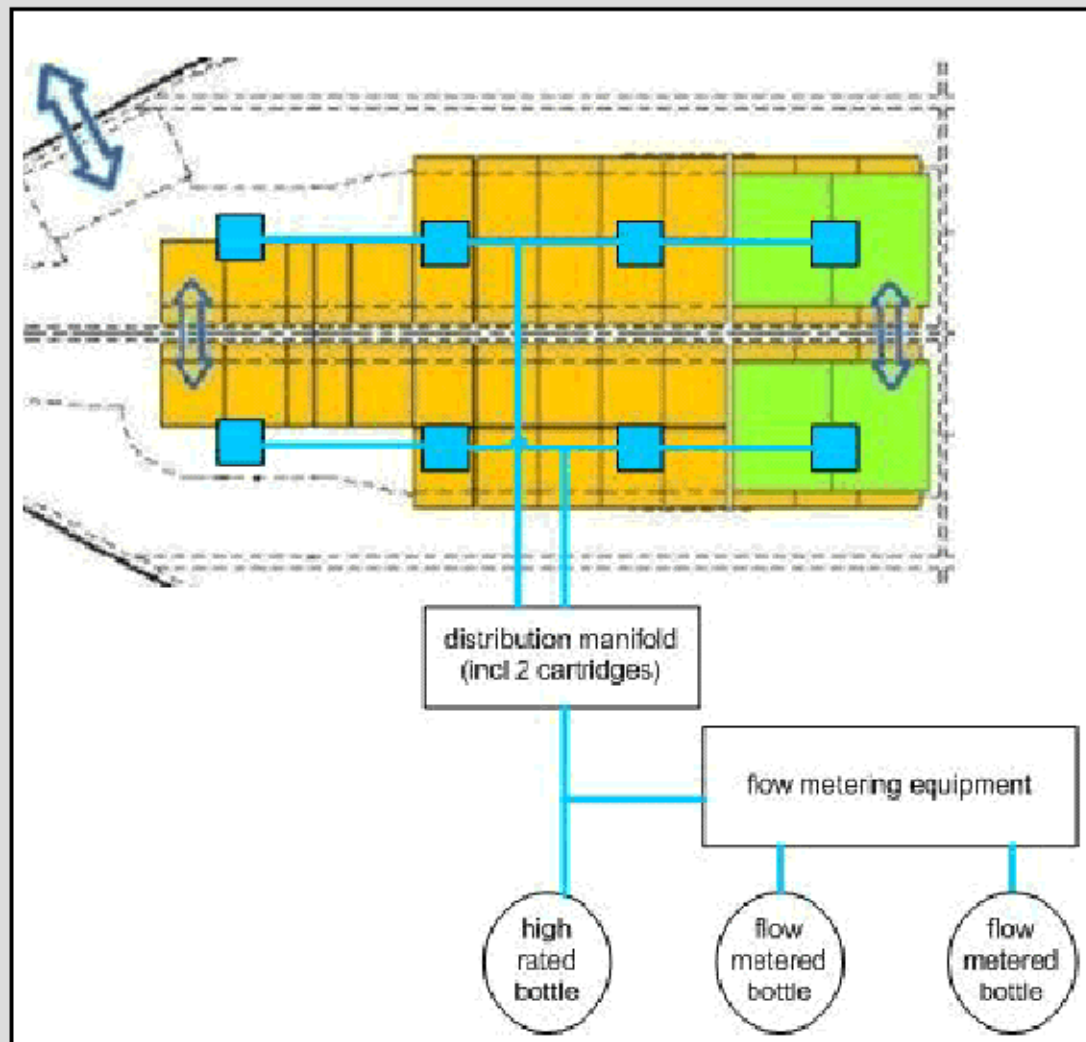

Steps in system
integration:

- 1.) System diagram
- 2.) Sizing
- 3.) Routing & ducting



System Integration

VELA 3 - Landing Gear Integration

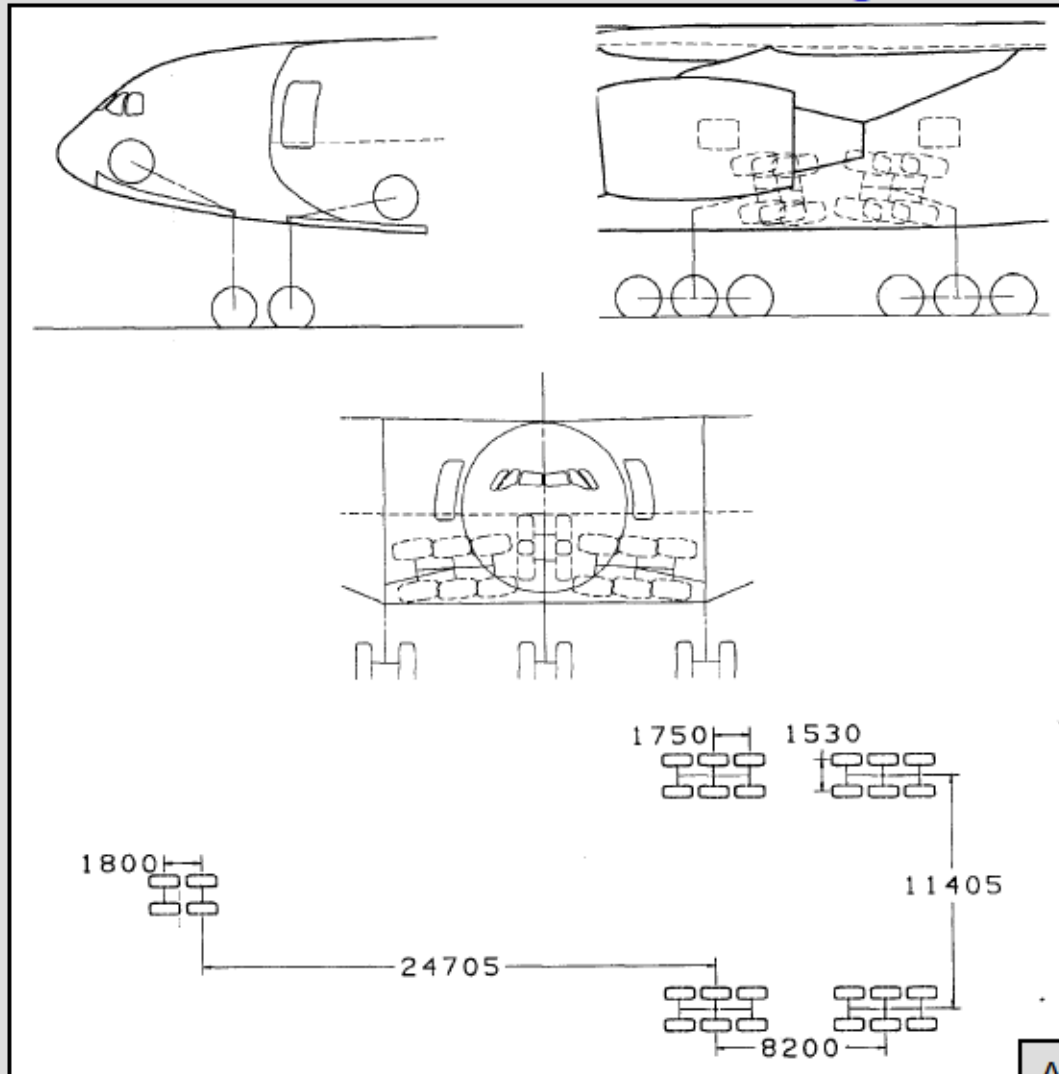

Twin tandem (Bogie) nose landing gear.
Two retraction mechanisms.

Two twin tri-tandem (6-wheel) main landing gears on each side.
Special retraction mechanism.

MLG wheel spacing only 11.4 m due to rib location (requirement: wheel spacing < 16 m)

Rule of Thumb: 30 t / MLG wheel => max. MTOW: 720 t



Hochschule für Angewandte
Wissenschaften Hamburg
Hamburg University of Applied Sciences



Air Transport System



Ground Handling



Hochschule für Angewandte
Wissenschaften Hamburg
Hamburg University of Applied Sciences

VELA 3 - Cargo Loading

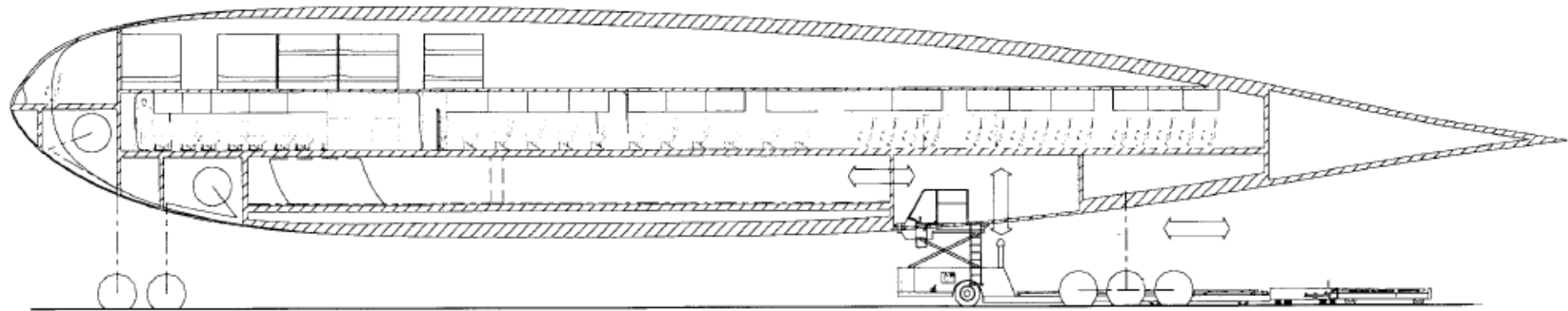

Airbus, FPO, Hamburg

A **cargo loading vehicle** drives in between the MLGs.
Cargo loading from below with lifting system.

Note also:

- 1.) **NLG / MLG** and wheel well positions.
- 2.) **Far aft position of MLG** => problem to rotate the aircraft on take-off.



Ground Handling

VELA 1 - Boarding

S. Lee, Diplomarbeit,
Hamburg University of Applied Sciences

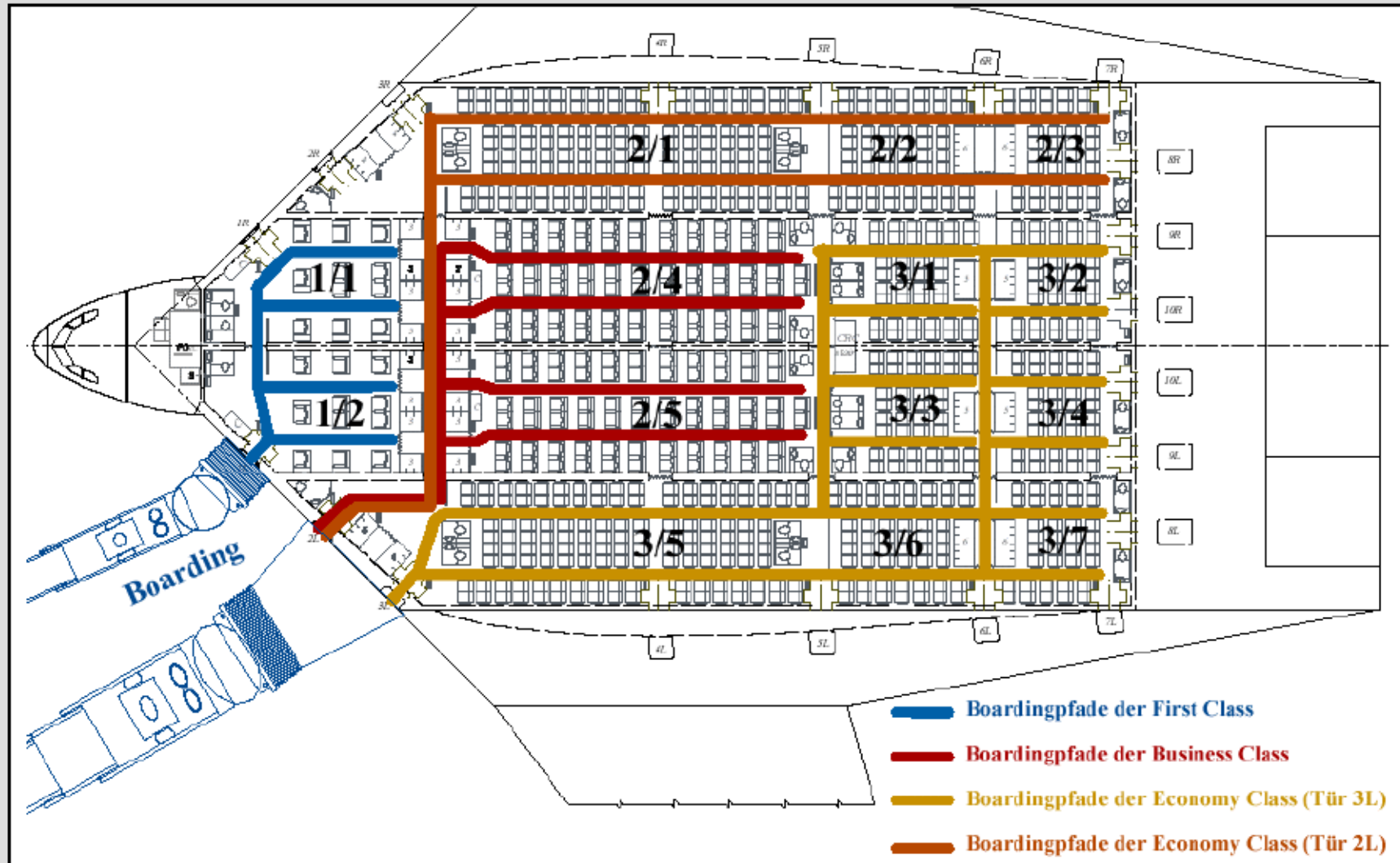



Ground Handling

VELA 1 - Turn Around Time

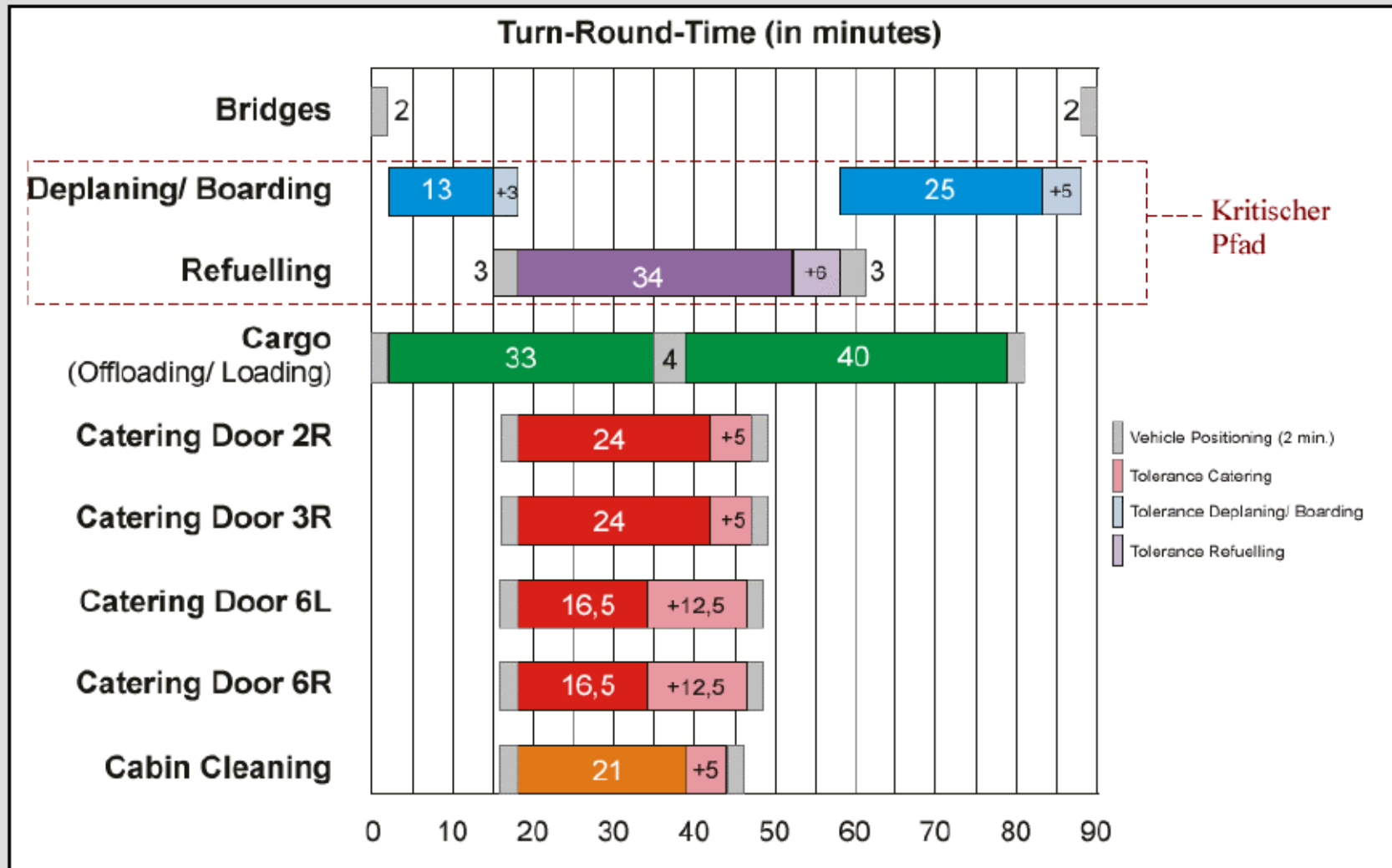



Emergency

VELA 1 - Emergency Evacuation

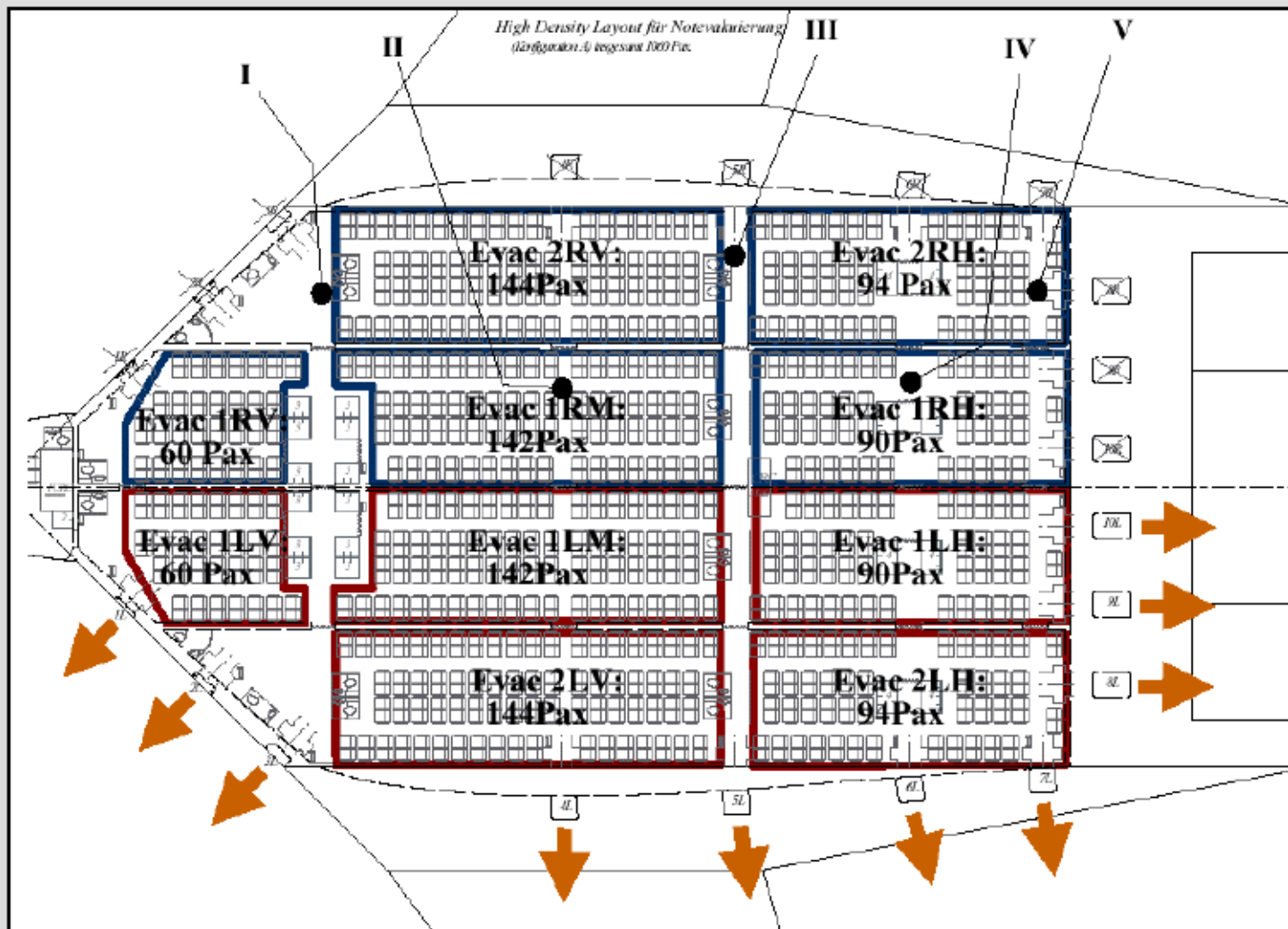



Emergency

Evakuierungsdauer und -aufteilung an den Türen 1L bis 10L

Türen	Evakuierungs- Zone (Evac)										Pax an Tür	Zeit [s]
	1LV	1LM	1LH	2LV	2LH	1RV	1RM	1RH	2RV	2RH		
Tür 1L	60					60	5				125	83
Tür 2L		34		35			32		20		121	81
Tür 3L		30		35			28		30		123	82
Tür 4L		26		37			32		25		120	80
Tür 5L		26		37			25		35		123	82
Tür 6L					32			27	34		93	62
Tür 7L					31			27		22	80	53
Tür 8L					31			18		32	81	54
Tür 9L		13	44				10	18		20	105	70
Tür 10L		13	46				10			20	89	59
Summe [Pax]	60	142	90	144	94	60	142	90	144	94	1060	

VELA 1 - Emergency Evacuation

Evacuation of possible in less than 90s if passengers are routed through their assigned door.

Evakuierungsdauer

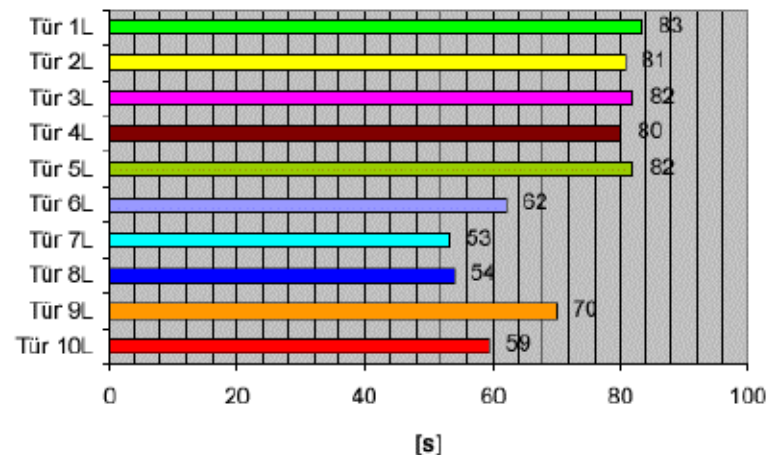



Emergency



Hochschule für Angewandte
Wissenschaften Hamburg
Hamburg University of Applied Sciences

VELA 1 - Emergency Evacuation - Slides - Ditching

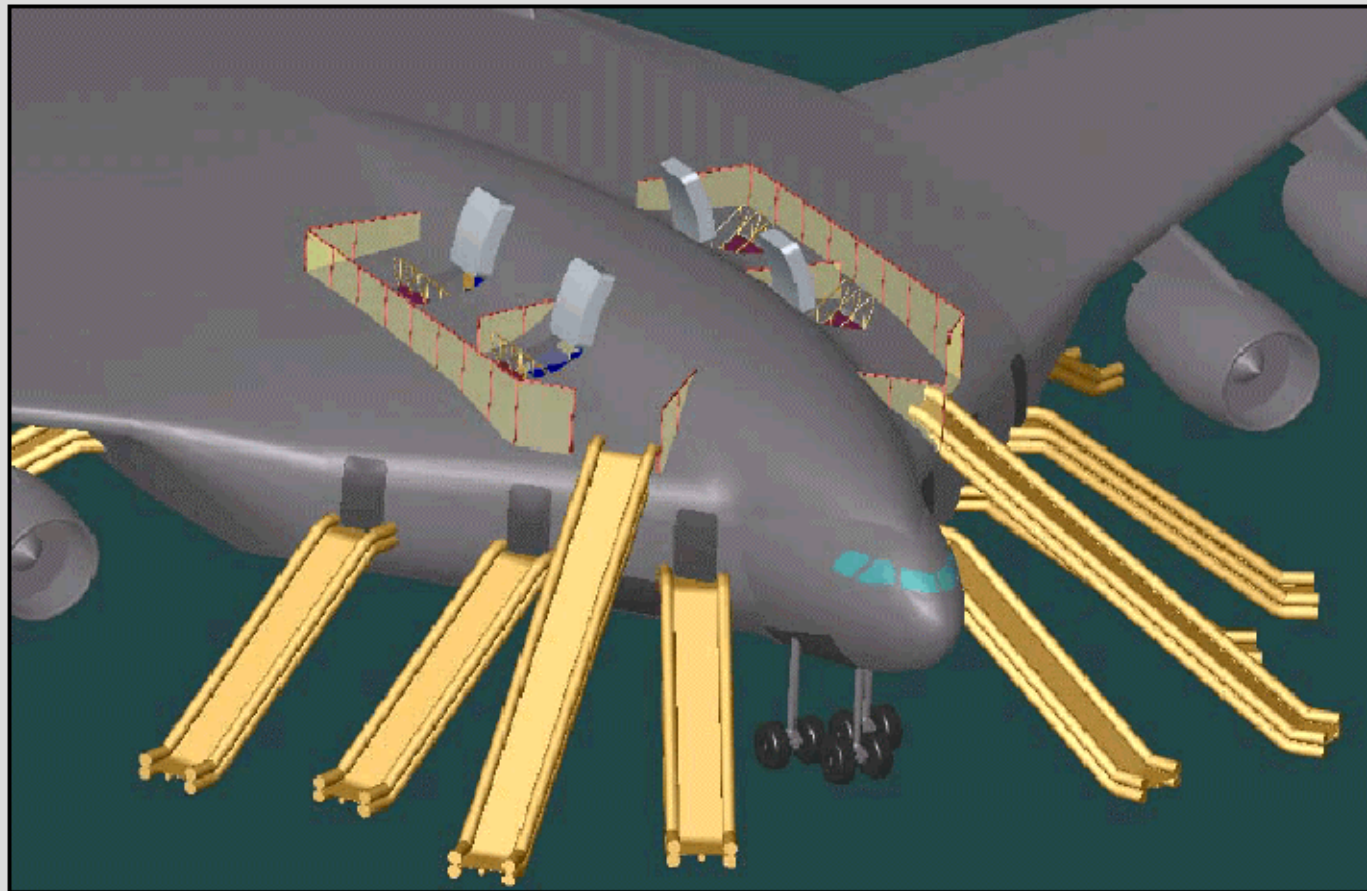

Slides on forward doors.

This modification of VELA 1 allows also evacuation after ditching (into the water) through over wing doors.

VELA 1, 2, 3 standard configuration can not be certified, because doors will be submerged.



Wake Turbulence

Wake Turbulence - Fundamentals

Wing tip vortices cause induced drag, D_i .

Wake turbulence cause a danger to following aircraft.

The initial strength of the wake turbulence is based on basic aircraft parameters:

$$P_{wake} = D_i V = \frac{2g^2}{\pi A e} \frac{m(m/S)}{\rho V}$$

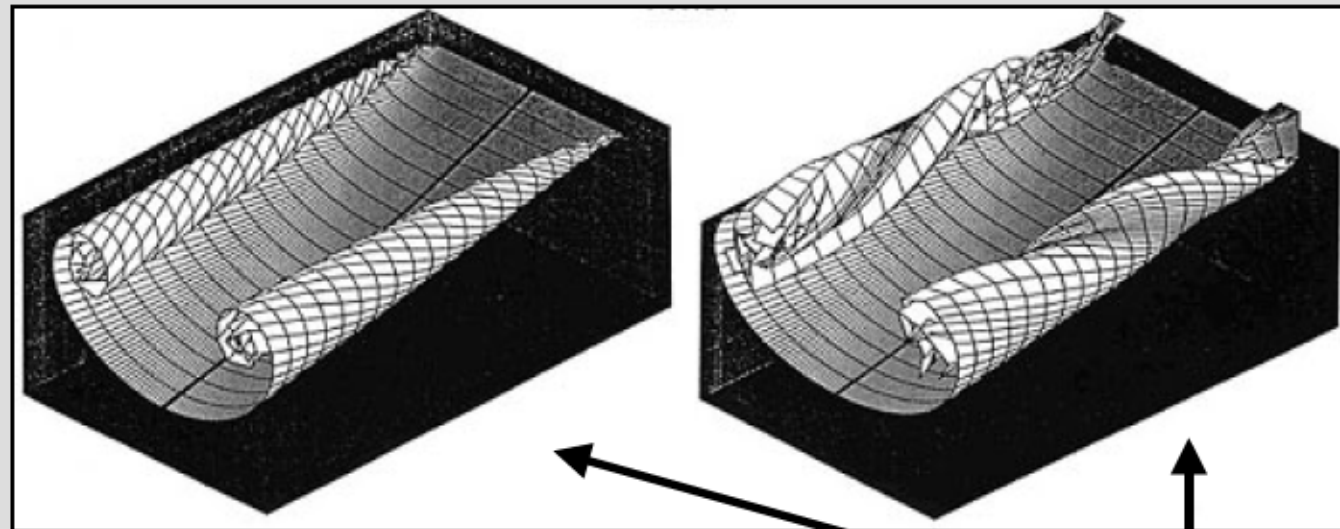

Decay of wake turbulence from a conventional wing and a C-wing.

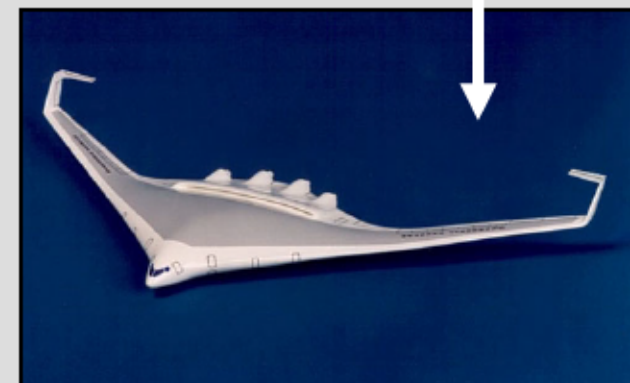

C-Wing-BWB:



Wake Turbulence

Wake Turbulence - Comparison

$$\frac{P_{wake,BWB}}{P_{wake,A380}} \approx \frac{A_{A380}}{A_{BWB}} \cdot \frac{m_{MTO,BWB}}{m_{MTO,A380}} \cdot \frac{(m/S)_{BWB}}{(m/S)_{A380}} = \frac{7.53}{4.83} \cdot \frac{700}{560} \cdot \frac{341}{663} = 1.00$$

with BWB-Data from VELA 3. Result: no major problems expected.

Wake Turbulence - Separation

IFR Minimum Separation Rules on Approach (nm)

Leading aircraft type ^a	Trailing aircraft type ^a		
	Small	Large	Heavy
Small	3.0	3.0	3.0
Large	4.0	3.0	3.0
Heavy	6.0	5.0	4.0

Source: FAA [1978]

^a Small: aircraft weighting no more than 12,500 lb. (5,625 kg)

Large: aircraft weighting more than 12,500 lb. (5,625 kg) and less than 300,000 lb. (135,000 kg)

Heavy: aircraft weighting in excess of 300,000 lb. (135,000 kg)

**A380 interim value:
10 NM**



Requirements from Aerodrome



Hochschule für Angewandte
Wissenschaften Hamburg
Hamburg University of Applied Sciences

ICAO and FAA Requirements on Aircraft Parameters for Airport Compatibility

Airport Category	Airplane Overall Length (m)
1	0-9
2	9-12
3	12-18
4	18-24
5	24-28
6	28-39
7	39-49
8	49-61
9	61-76

VELA 3: 65 m



Requirements from Aerodrome

ICAO aerodrome reference codes [ICAO, 1999]

Aerodrome code number	Reference field length (m)	Aerodrome code letter	Wingspan (m)	Outer main gearwheel span (m)
1	<800	A	<15	<4.5
2	800-<1200	B	15-<24	4.5-<6
3	1200-<1800	C	24-<36	6-<9
4	≥1800	D	36-<52	9-<14
		E	52-<65	9-<14
		F	65-<80	14-<16

FAA airport reference codes [FAA, 1989] **VELA 3: 11,4 m**

Aircraft approach category	Aircraft approach speed (kn)	Aeroplane design group	Aircraft wingspan (m)
A	<91	I	<15
B	91-<121	II	15-<24
C	121-<141	III	24-<36
D	141-<166	IV	36-<52
E	≥166	V	52-<65
		VI	65-<80

VELA 3: 99,6 m



Requirements from Aerodrome

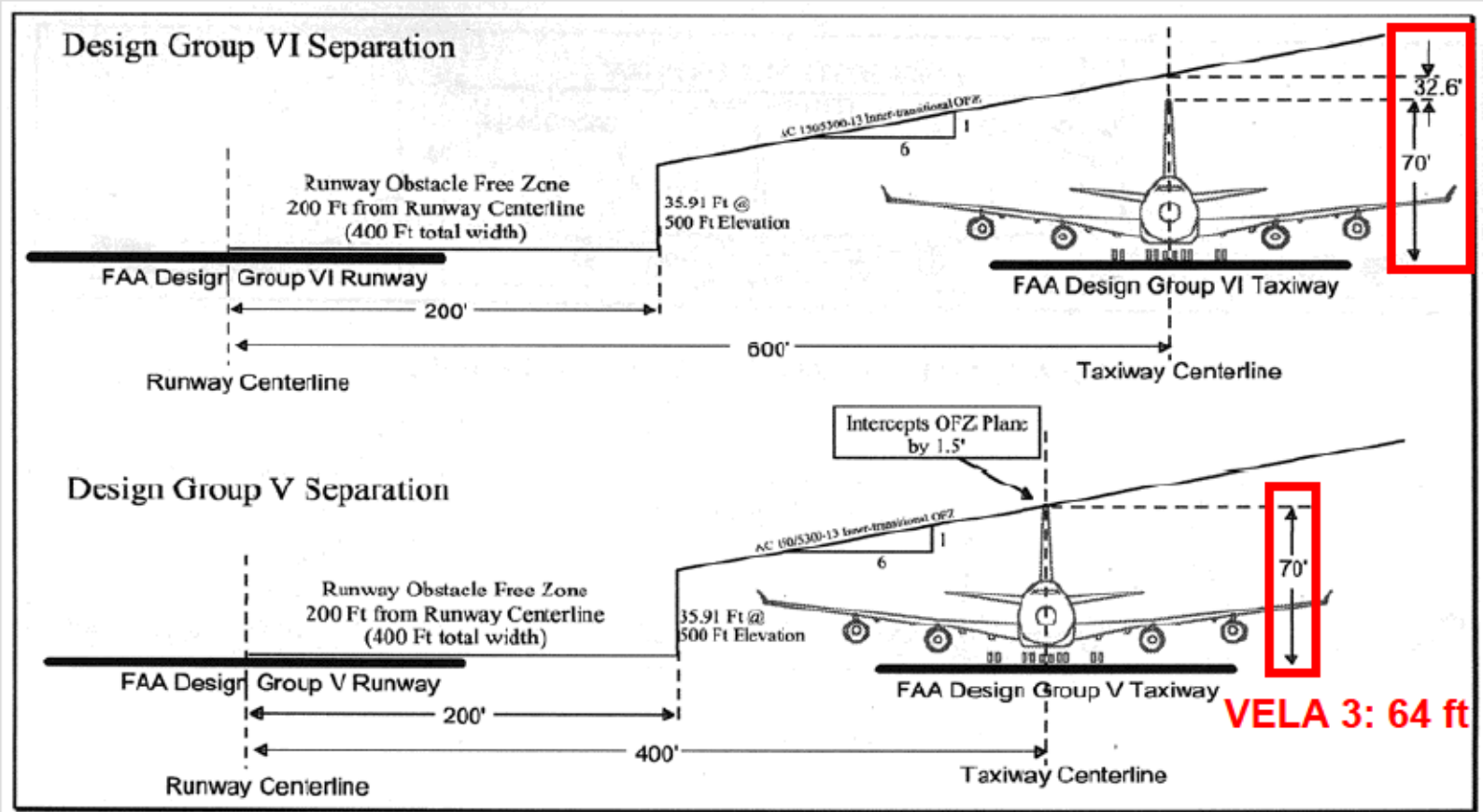

**Clearance between runway and parallel taxiway (FAA 1998) =>
Maximum aircraft height (80 ft).**



Requirements from Aerodrome

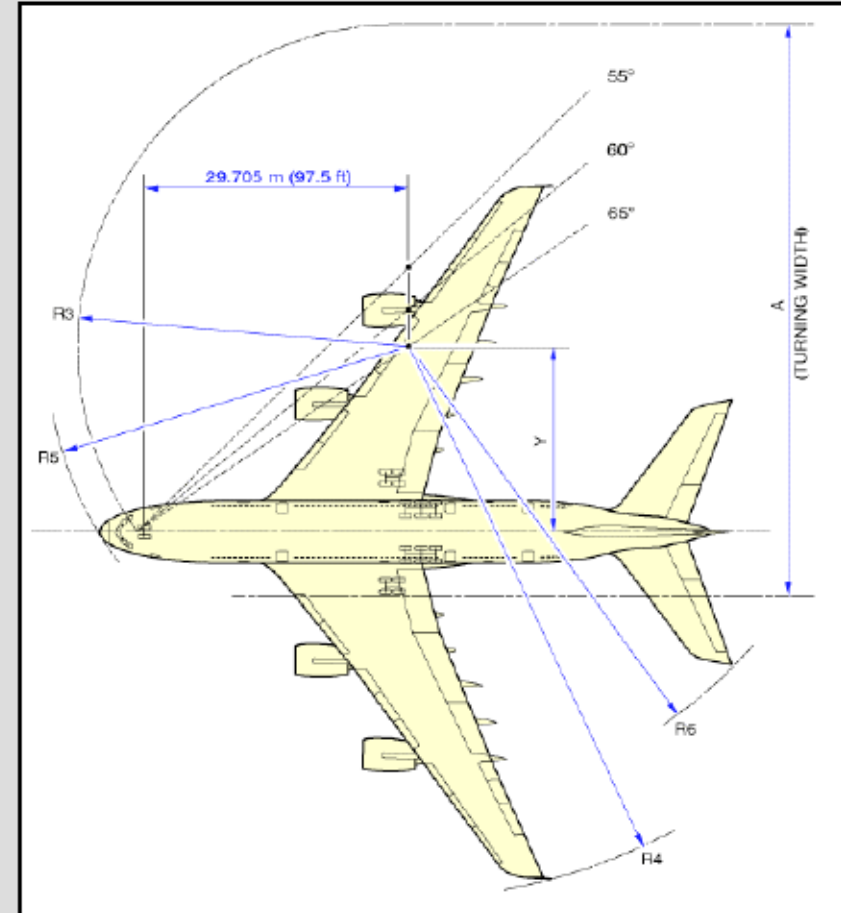
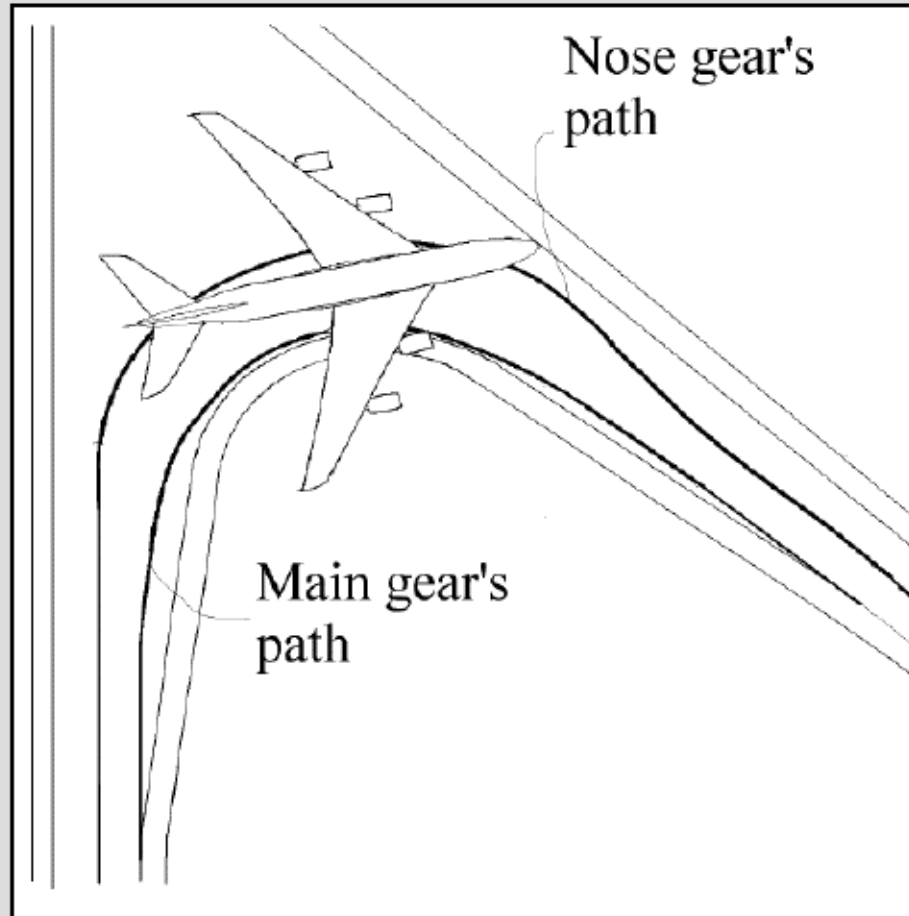

Turning radius and taxiway fillets for aircraft turning.

Wheel span: A380: 12.5 m
 VELA: 11.4 m => similar turn characteristic.



Interior Design

VELA 1 - Cabin Layout

Diplomarbeit: S. Lee

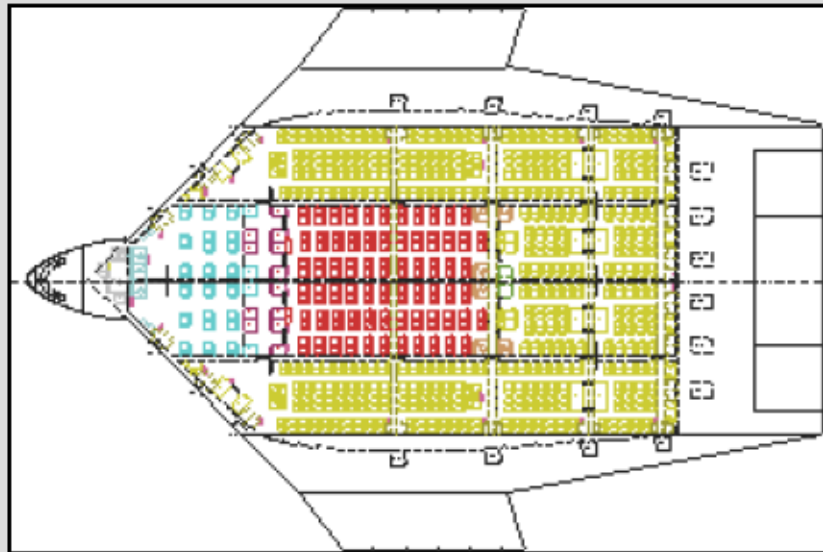

Vertical acceleration for pax on outer seats.

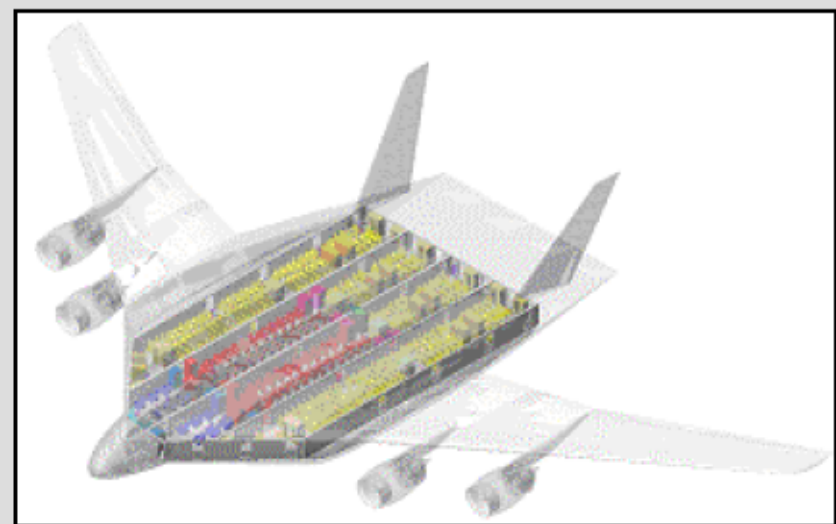
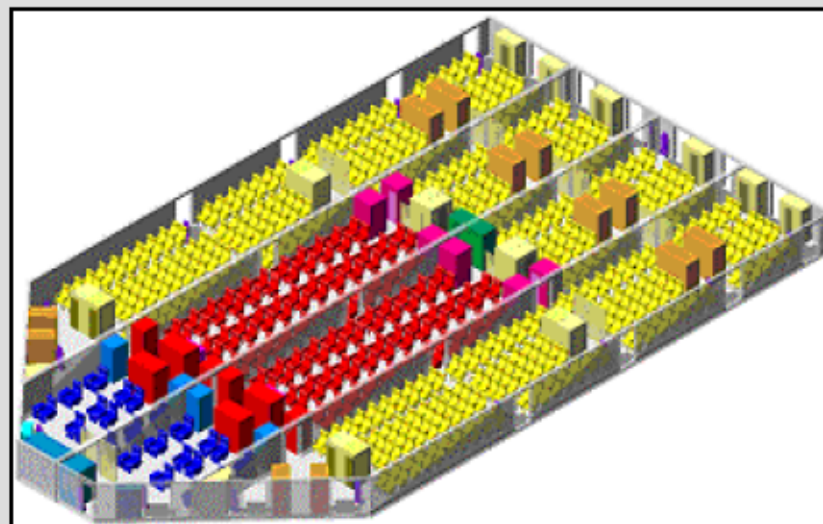
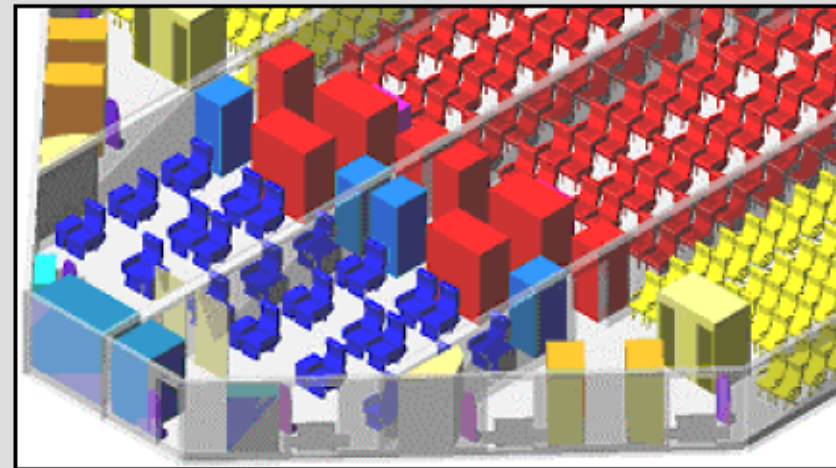



Interior Design



Hochschule für Angewandte
Wissenschaften Hamburg
Hamburg University of Applied Sciences

Double Deck BWB

W. Granzeier

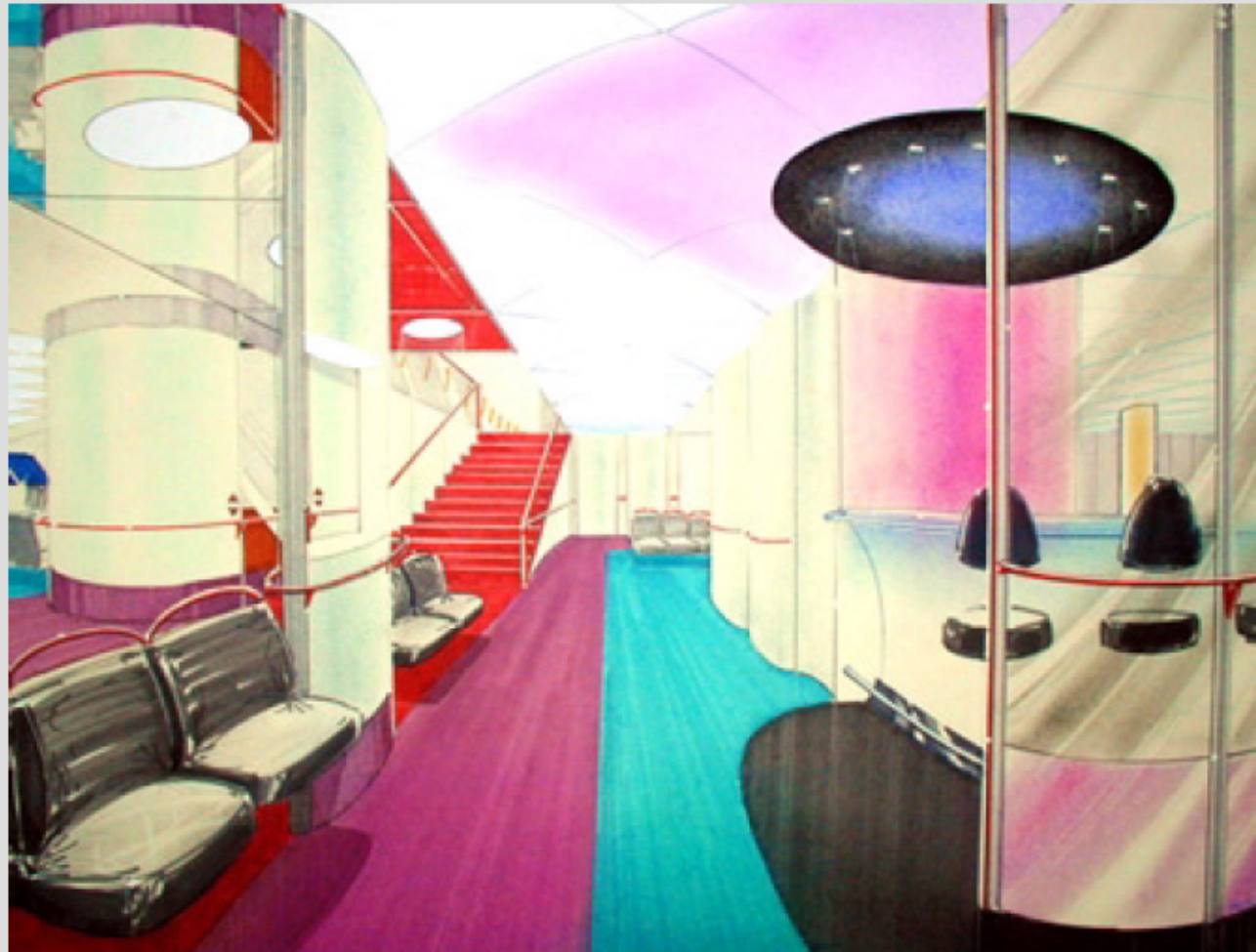



Interior Design



Hochschule für Angewandte
Wissenschaften Hamburg
Hamburg University of Applied Sciences

Underfloor Usage - Artificial Windows

W. Granzeier

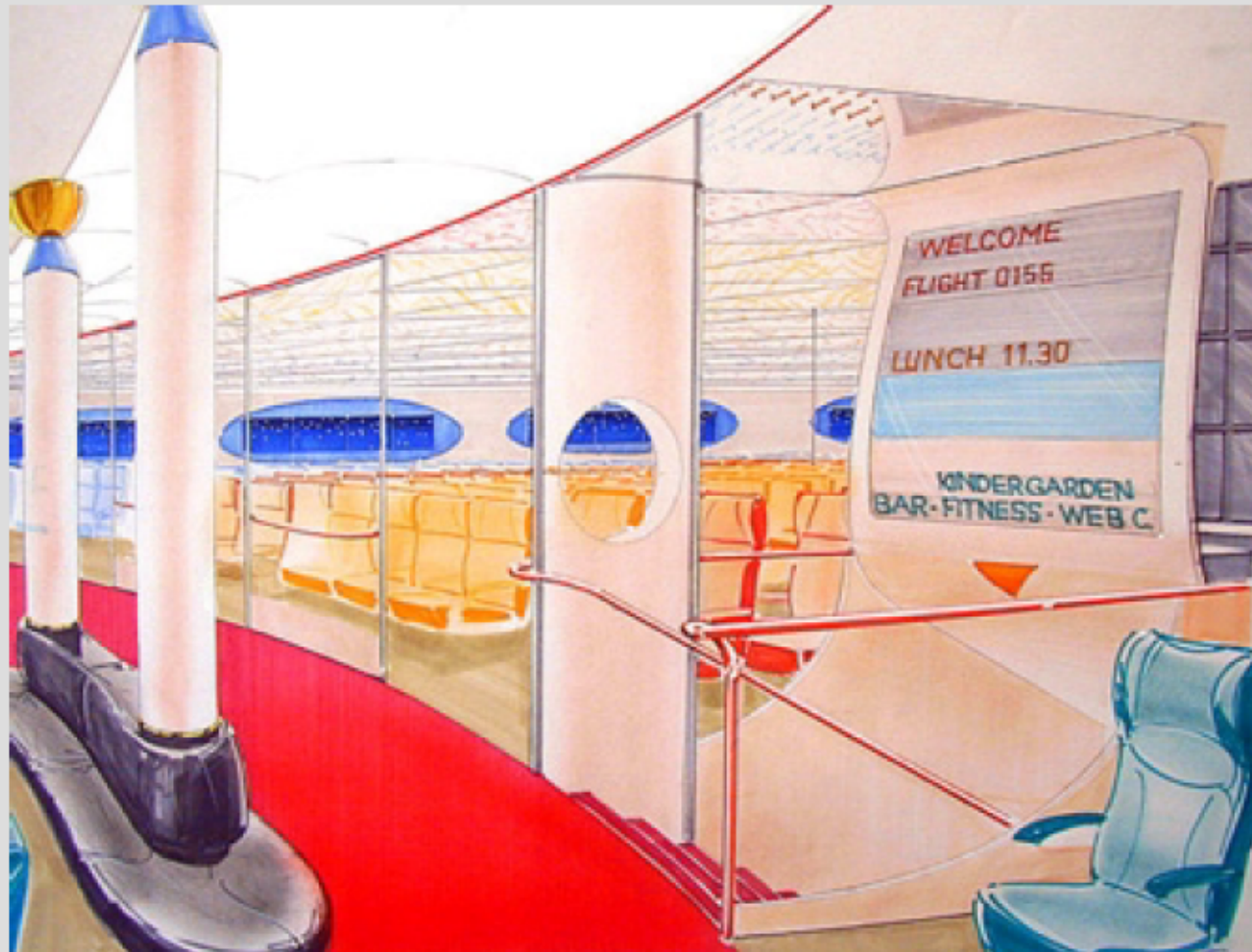



Interior Design



Hochschule für Angewandte
Wissenschaften Hamburg
Hamburg University of Applied Sciences

BWB Center Wing Shapes from Inside

W. Granzeier





Hochschule für Angewandte
Wissenschaften Hamburg
Hamburg University of Applied Sciences



AC20.30

<http://www.haw-hamburg.de/f/personal/projekte/Blended-Wing-Body.html>
<http://www.ac2030.de>



AC20.30



Hochschule für Angewandte
Wissenschaften Hamburg
Hamburg University of Applied Sciences

Test Flights

AC20.30 Parameters

Scale	1:30
Span	3.24 m
Length	2.12 m
MTOW	12.5 kg
Engines	2 electric driven fans
Thrust	2 x 30 N
Power input	2 x 1400 W

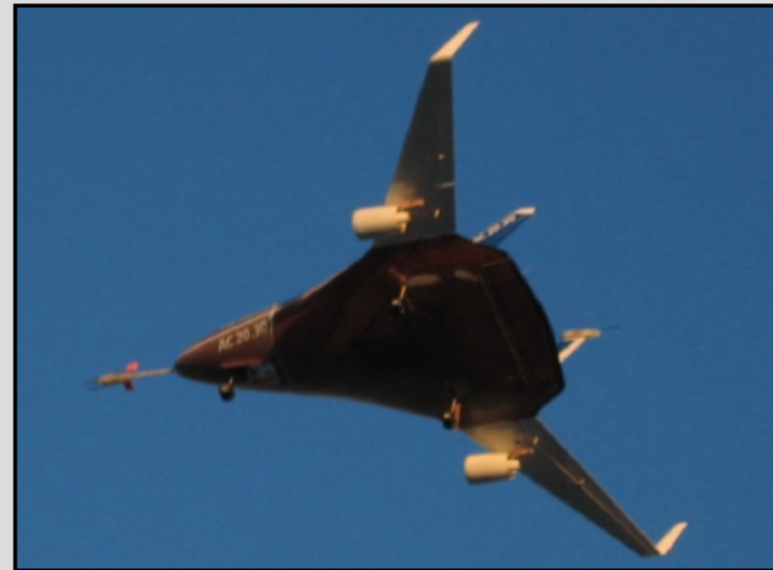



AC20.30

Test Flights

Recorded Parameters

- barometric height, two temperatures
- voltage, current
- air speed, engine RPM
- GPS-Coordinates (=> position and ground speed)
- angle of attack, side slip angle
- 3 accelerations, 3 rotational speeds
- position of 4 control surfaces
- turn coordinator, ping, airborne camera picture

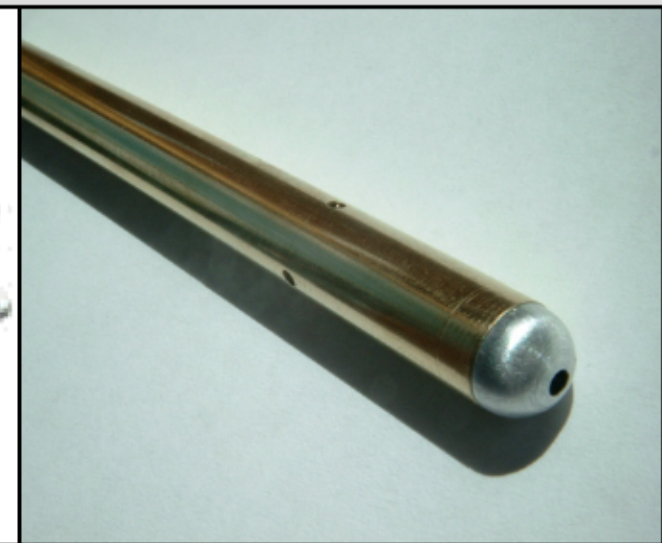
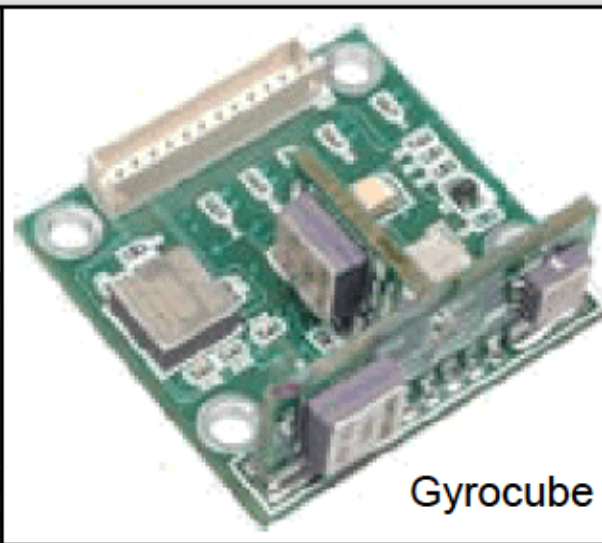



AC20.30

K. Danke, Diplomarbeit, Hamburg University of Applied Sciences

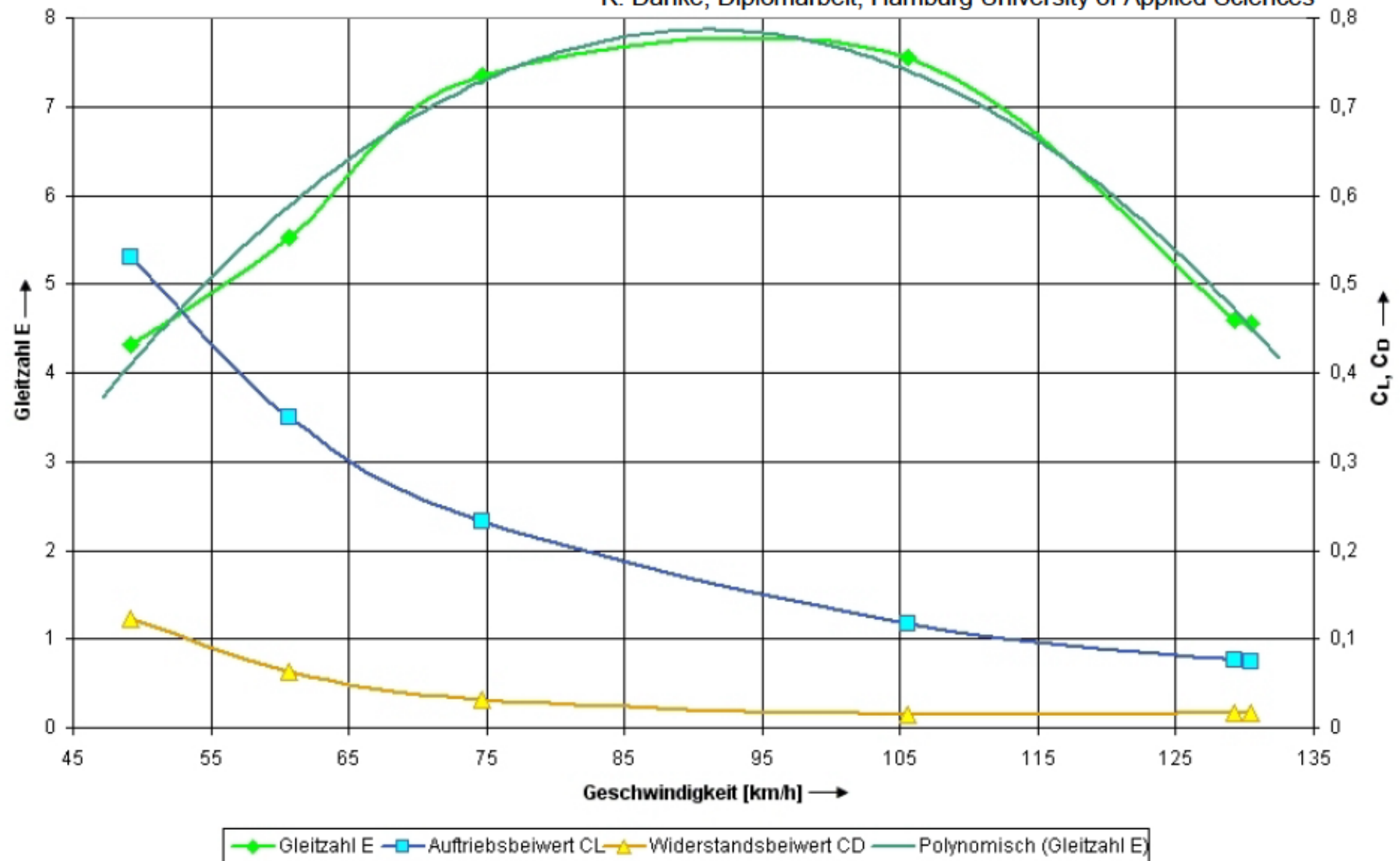



AC20.30

Euler Angles form Test Flights with "Gyrocube"

$$U = V_T \cos \beta \cos \alpha$$

$$V = V_T \sin \beta$$

$$W = V_T \cos \beta \sin \alpha$$

$$a_x = \dot{U} + QW - RV + g \sin \Theta$$

$$a_y = \dot{V} + RU - PW - g \cos \Theta \sin \Phi$$

$$a_z = \dot{W} + PV - QU - g \cos \Theta \cos \Phi$$

← solved for pitch angle, Θ

← solved for roll angle, Φ

← check results

Experience with Measurement Technique:

Simple and inexpensive method.

Drift problems are simply not present.

Good results only for manoeuvres with moderate dynamic.



AC20.30



Hochschule für Angewandte
Wissenschaften Hamburg
Hamburg University of Applied Sciences

Wind Tunnel Tests





AC20.30



Hochschule für Angewandte
Wissenschaften Hamburg
Hamburg University of Applied Sciences

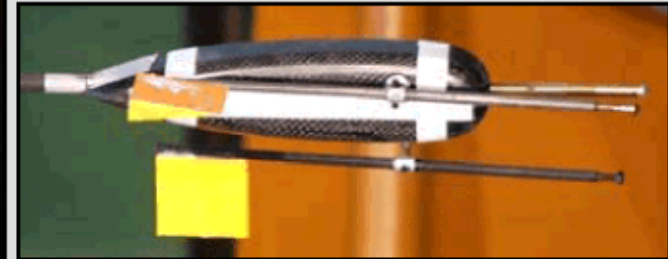

H. Zingel

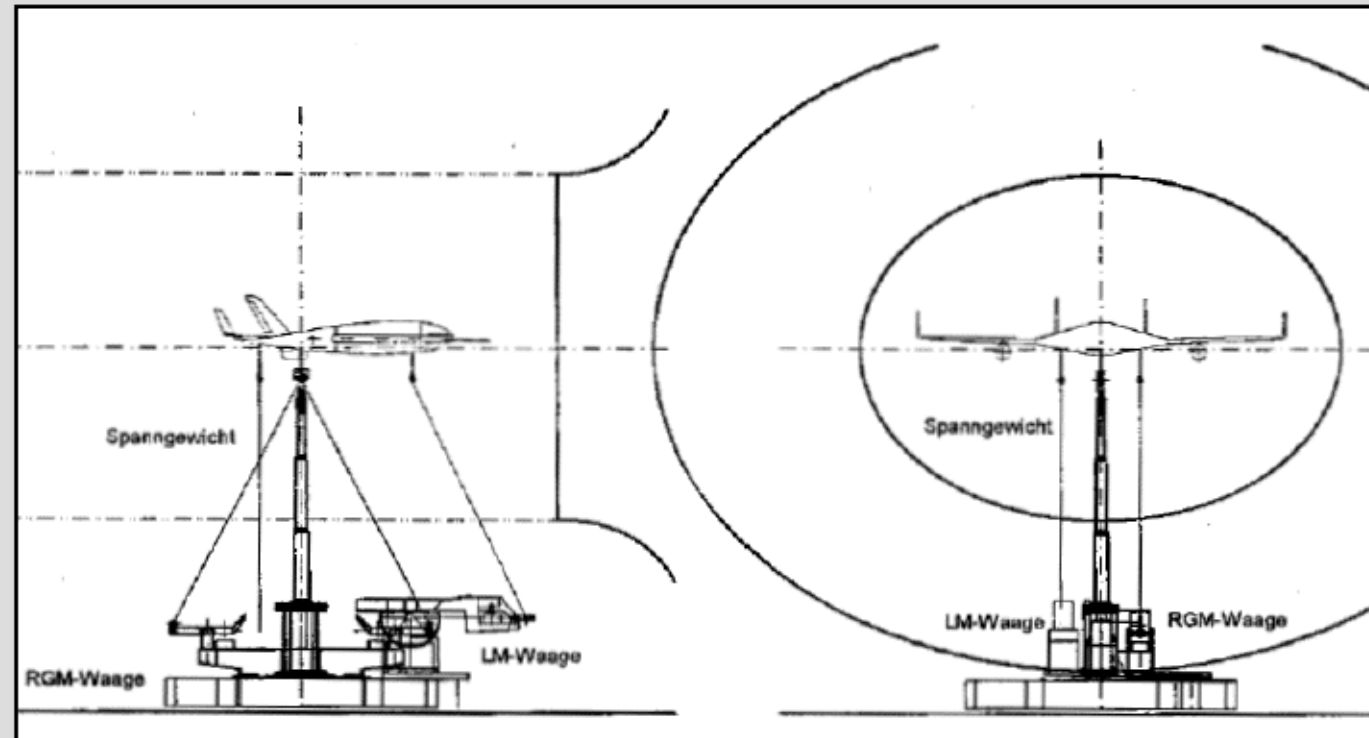



AC20.30

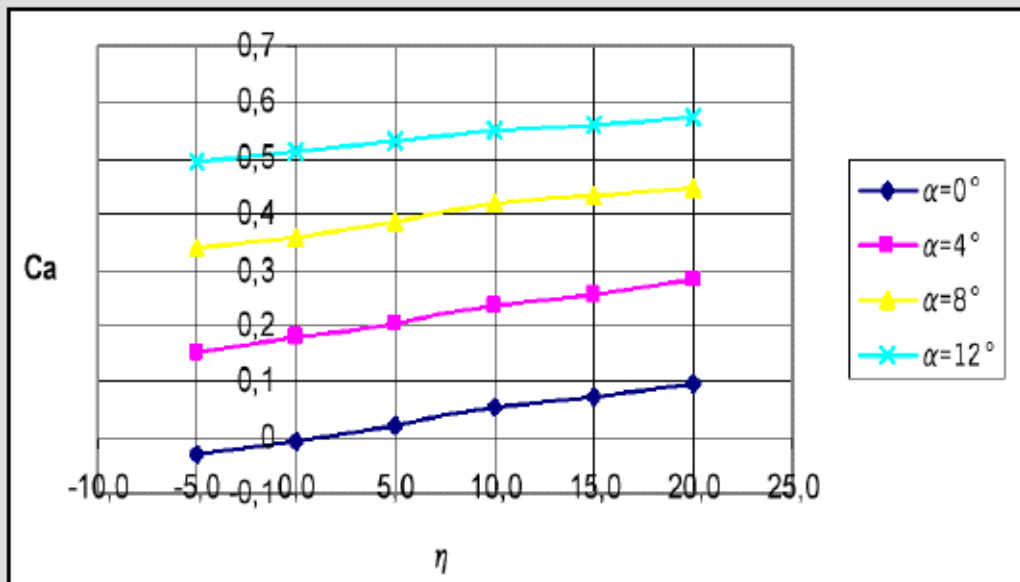
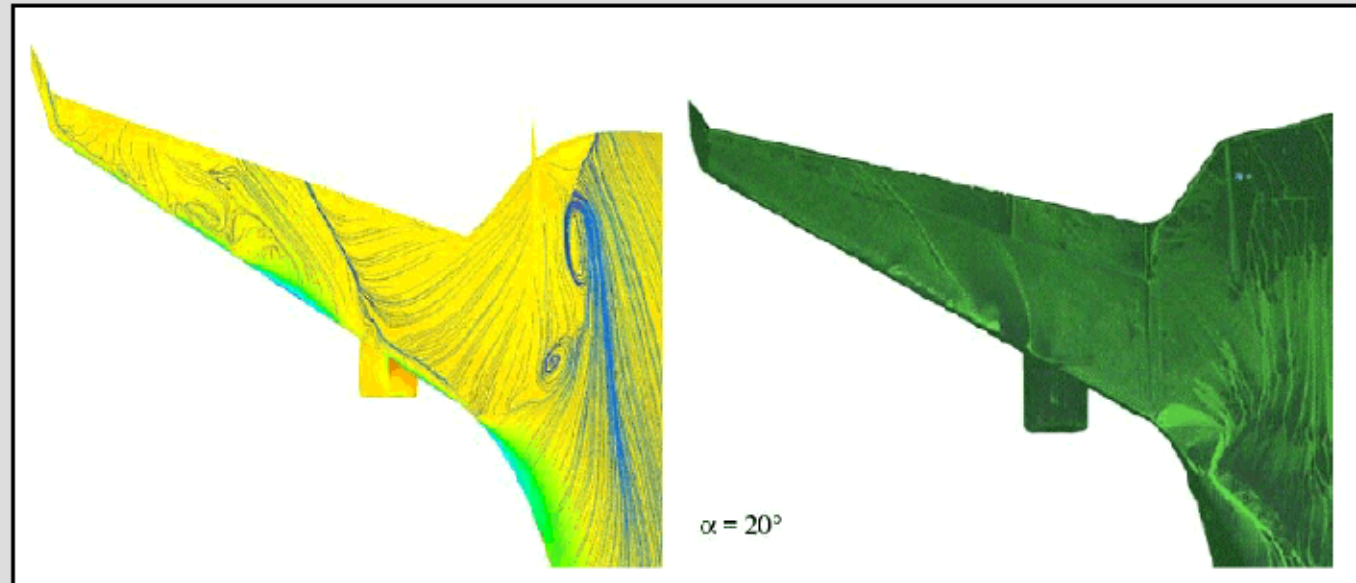

CFD surface stream lines (left)
Fluorescend paint in wind tunnel (right).

Lift coefficient dependend on flap angle
(wing) and angle of attack.



Hochschule für Angewandte
Wissenschaften Hamburg
Hamburg University of Applied Sciences



Summary

W. Granzeier



Summary

BWB actual advantages compared to today's advanced aircraft (summary of results from this investigation)

reduction in weight :	single shell required. In this case: 8% better
better L/D :	10 to 15% better (not apparent from AC20.30)
reduction in fuel consumption :	yes, due to L/D
reduction in emissions :	yes, lower CO ₂ emissions due to less fuel burn
reduction in noise :	only with engines on top
increase of airport capacity :	yes, more than 750 pax per A/C (probably no problems with wake turbulence)
reduction in DOC :	down ??% (mostly due to scale effect)
But:	
open certification problems :	unstable configuration (?), ditching
open design problems :	rotation on take-off, landing gear integration, ...



AC20.30 Flight Test

Flight Test Video:

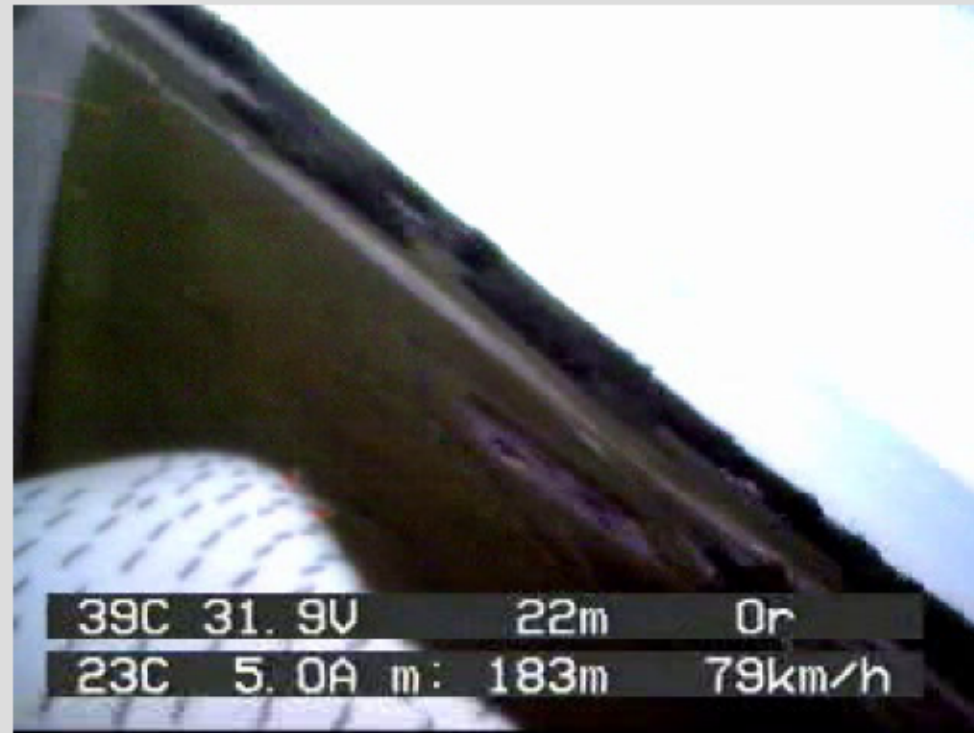



The End



Hochschule für Angewandte
Wissenschaften Hamburg
Hamburg University of Applied Sciences

W. Granzeier

